

# Faucets





**In today's fast-paced world, the bathroom has become more than just a functional space - it is a tranquil retreat where you can relax, recharge and reconnect with yourself. Enhancing wellbeing starts with the small yet significant details, like the faucet you use every day. Thoughtfully designed faucets and shower solutions play a key role in transforming your bathroom into a sanctuary of comfort and relaxation.**

**At the forefront of bathroom innovation, advanced technology is seamlessly integrated into our timeless designs to prioritise both energy and water efficiency. From basin and kitchen faucets to smart showers and solutions for public spaces, each product delivers outstanding performance, allowing you to make sustainable choices without compromising on comfort or style. Experience the perfect balance of beauty, functionality, and sustainability in every drop, elevating your daily routine into a ritual of wellbeing.**

# Contents

<b>A World of Innovation</b>	<b>6</b>
<b>Made to Last</b>	<b>16</b>
<b>Basin Area</b>	<b>34</b>
<b>Shower and Bath Shower Area</b>	<b>120</b>
<b>Kitchen Area</b>	<b>184</b>
<b>Public Spaces</b>	<b>194</b>
<b>Quick Guides</b>	<b>216</b>
<b>About Roca</b>	<b>222</b>
<b>Sustainability</b>	<b>224</b>



6



16



34



120



184



194



216



222



224

# A World of Innovation



At the heart of our commitment to excellence is the Faucets Competence Centre in Basel, Switzerland, a beacon of innovation where we shape the future of bathroom design. With a passion for creating solutions that fuse form and function, we focus on developing products that not only meet tomorrow's needs, but also inspire a new era of energy efficiency, sophisticated design and exceptional performance.

In a world of rapid change, we believe in the power of continuous transformation. Our relentless commitment to advancing manufacturing technologies ensures we stay ahead of market demands. We don't just react to change, we drive it, setting new standards of quality and operational excellence.

Our focus on innovation extends to every detail, from advanced finishing techniques to sustainable, high-performance materials. Every faucet we create is a testament to our vision: to deliver products that are not only durable and reliable, but also inspiring in their beauty, functionality and environmental responsibility.





## Global Capacity

We are dedicated to improving the quality of our faucets and driving excellence in every aspect of the bathroom environment. Our Faucets Competence Centre in Basel, Switzerland, is at the forefront of developing innovative solutions to meet future market demands for energy efficiency and design. By using the latest materials and advanced manufacturing technologies, we are constantly evolving our expertise and maintaining the highest standards of excellence.



## Industrial Leadership and Legacy

In a rapidly changing and complex environment, continuous evaluation of processes and resources is essential. Our product range is constantly being adapted to increase agility and responsiveness to market demands. Significant investments are made each year to advance manufacturing technologies, including the automation of assembly processes and the expansion of production capacity, to ensure operational efficiency and the maintenance of high quality standards.

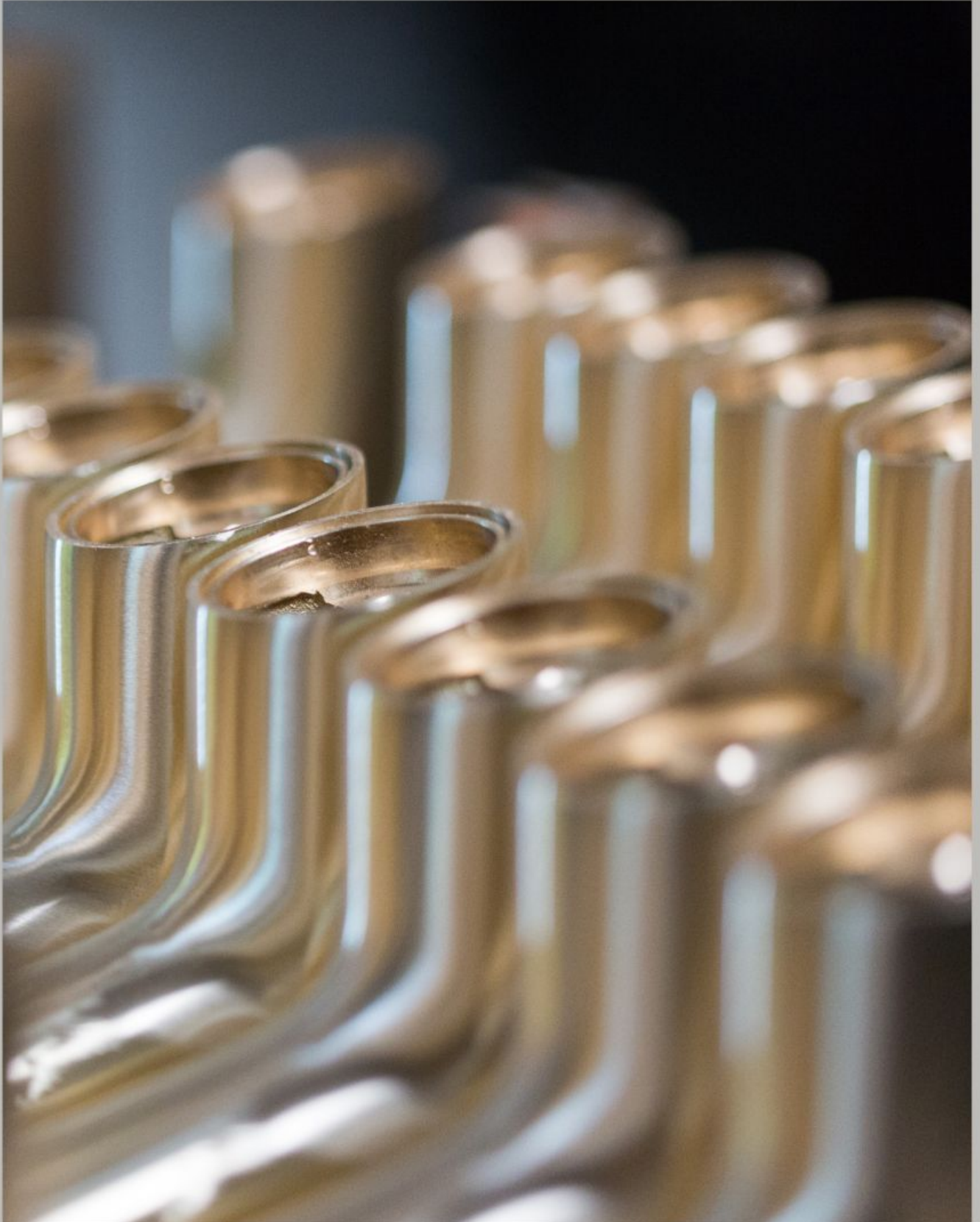

## Advanced Finishing Technologies

With advanced finishing technologies and stringent quality standards, we combine innovative processes with a focus on durability, aesthetics and environmental responsibility across our faucet collections. Using state-of-the-art techniques like PVD (Physical Vapour Deposition), powder coating, and trivalent chrome, we offer a wide range of colour and texture options to meet modern design trends while ensuring long-lasting performance. Each finish is tested to meet stringent regulatory and internal requirements for corrosion resistance, adhesion, hardness, and colour stability, ensuring that each product delivers high performance and reliability in a variety of environments.

### **PVD (Physical Vapour Deposition)**

PVD is a high-tech metal coating process that produces exceptionally durable, vibrant finishes. Components are pre-treated and then placed in specialised reactors where a near absolute vacuum is created. A combination of gases creates a plasma atmosphere, allowing high-voltage discharges to fuse precious metal atoms to the surface of the product. This atomic level bonding creates finishes that are visually striking and highly durable. Our PVD finishes - titanium black, brushed titanium black, rose gold, stainless steel and brushed brass - are renowned for their hardness and resistance to corrosion and wear, making them ideal for high-traffic areas where both durability and style are essential.





### **Powder coating**

For a wider range of colours beyond metallic tones, we use electrostatic powder coating technology. This process applies a layer of polymer with nanoparticles to improve surface durability and meet our stringent quality standards. Our powder-coated finishes include matt black, matt white and the vibrant colours from the Nu faucet collection. They are rigorously tested for adhesion, colour consistency and chemical resistance, ensuring they stand up to daily use while adding distinctive style to any space.

### **Trivalent Chrome**

In a commitment to both quality and environmental responsibility, we have replaced the hazardous hexavalent chrome with trivalent chrome (CRIII) in our European facilities. This advanced process maintains the durability and aesthetic qualities associated with chrome finishes, while significantly reducing health risks to workers and environmental impact. Our switch to trivalent chromium demonstrates a proactive approach to safer, sustainable manufacturing practices and sets a new standard for responsible manufacturing in the industry.



## Enduring excellence

A strong commitment to our customers fuels the meticulous craftsmanship behind each of our faucets, where durability, quality and exceptional finishes set industry standards. Rigorous testing ensures that each product meets certified benchmarks, guaranteeing lasting performance and the highest quality products.



### Best-in-class standards

High-quality raw materials are used to create alloys and surface coatings for our faucets and components that are widely recognised as superior to industry standards. To ensure certified quality, every faucet undergoes extensive factory testing, including contact surface studies, and sensitivity, reliability and fidelity checks, and endurance tests. With over 1,000,000 movements, our products are subjected to rigorous durability testing that exceeds EN standards, while single lever ceramic cartridges pass a 50-bar hammer test certified by NF-ECAU. The Roca Quality Standard NGC 5001 reflects global benchmarks as well as Roca's extensive market and product knowledge.



## Design with purpose

Faucet performance and durability is defined by the finely tuned engineering of the internal components, with the cartridge playing a key role in managing water flow, temperature mixing and outlet selection. To meet a wide range of needs in terms of performance, ease of use and aesthetics, we've developed a number of specialised cartridges, from single-lever mixers and ceramic diverters to thermostatic and electronic cartridges. Each is designed to improve reliability, efficiency and user experience.

Our **ceramic disc cartridges**, made from alumina ceramics ( $\text{Al}_2\text{O}_3$ ) using advanced manufacturing techniques, are exceptionally durable and resistant to chemicals. The diamond-hard ceramic surfaces provide smooth, quiet operation and precise water control, while tight tolerances and carefully matched surfaces ensure a consistently smooth experience every time.



For temperature accuracy, our **thermostatic wax mixer cartridges** incorporate the latest wax cup technology to provide fast, stable adjustments regardless of flow or pressure changes. These cartridges offer reliable temperature control, enhanced by safety features like anti-scald and anti-scale functions. Designed with stability, comfort, and energy efficiency in mind, our thermostatic cartridges ensure a reliable and enjoyable water experience every time.

# Made to Last

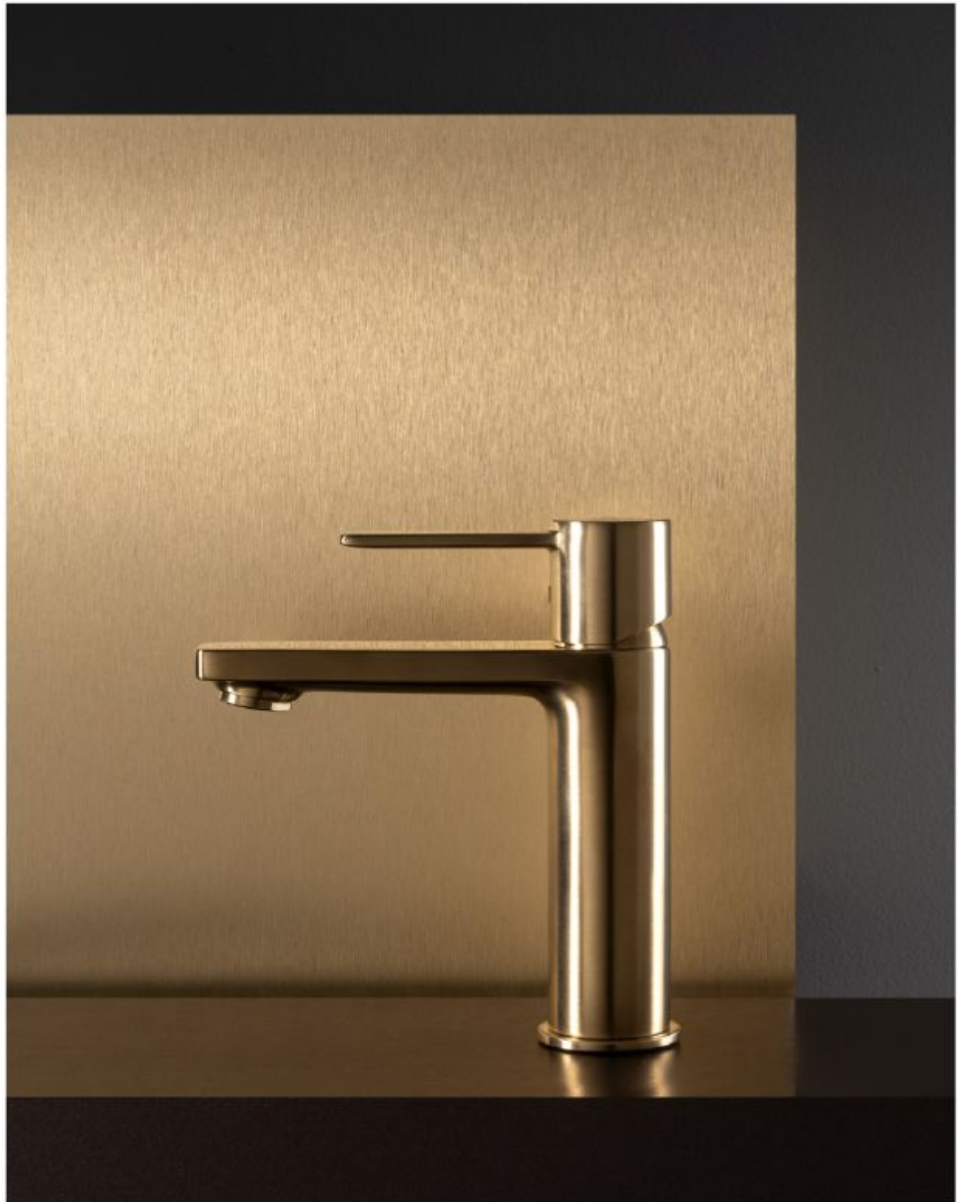



Building on our commitment to improve everyday life, our faucet collections embody a fusion of innovation, design and sophistication that enhances the modern bathroom experience. With advanced technology and timeless aesthetics, these collections seamlessly integrate into any space, from residential bathrooms to public installations, meeting the diverse needs of today's consumers.

Meticulously crafted to enhance both aesthetic appeal and user interaction, basin faucets are available in a wide range of designs, heights and finishes, ensuring a perfect fit for any bathroom style. These products embody a commitment to sustainability, incorporating the Cold Start system and advanced flow limiters that significantly reduce water and energy consumption.

Comfort and safety are paramount, particularly in the shower, where personalisation options allow for precise control of flow and temperature, creating a luxurious experience. In public and semi-public environments, the focus shifts to hygiene, accessibility and efficient resource management, promoting welcoming and inclusive spaces that uphold sustainability. Made from premium materials, these faucets ensure long-lasting resistance to wear and tear, while retaining their elegance over time.



## Efficient and Sustainable living

Energy and water saving technologies are essential for improving household efficiency and reducing environmental impact. By incorporating smart features into everyday appliances, these technologies help to significantly reduce energy and water consumption, leading to lower utility bills and a more sustainable lifestyle.

### Energy Saving

Cold Start technology is designed to optimise energy use by activating the boiler only when the handle is turned to the hot water position. With a centrally positioned handle that starts with cold water, hot water is gradually introduced as the handle is turned to the left.

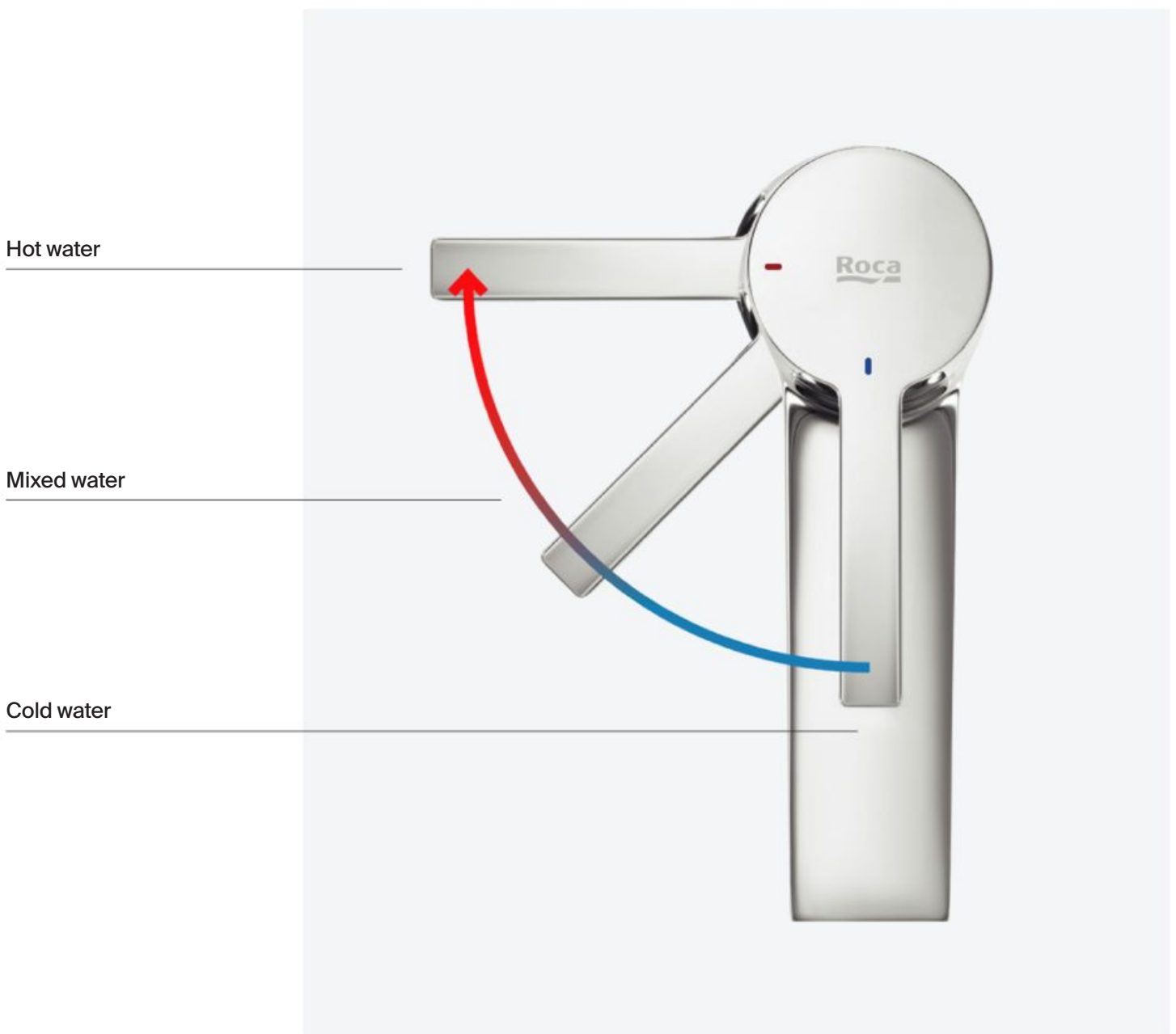



Targa basin mixer in stainless steel finish

### **Water savings**

The latest generation flow limiters offer significant water savings by limiting the flow to a maximum of 5 litres per minute, regardless of the pressure system.

### **Homogeneous flow**

Aerators provide a consistent, high quality aerated jet quality, even under varying pressure conditions. With anti-limescale protection, they facilitate cleaning and maintenance, ensuring optimum performance over time.

# A Perfect Fit

## Five sizes, endless options

When it comes to selecting the perfect faucet for your bathroom or kitchen, size matters. Faucets are available in a range of sizes, each designed to suit specific needs and spaces. From the compact and space-saving XS faucets to the grand and stylish XL faucets, there is a size to cater to every requirement and aesthetic preference.



### XS-Size

Compact-sized faucets suitable for use in small spaces or for single-use purposes, such as in a cloakroom.

### S-Size

Standard-sized faucets, comfortable and appropriate for most standard bathrooms.

### M-Size

Medium-sized faucets, versatile and suitable for a wide range of basin sizes. Perfect balance between functionality and style, with a higher body and longer spout.

### L-Size

L-Size faucets are larger than the average faucet, with side handle and high spout. Useful for washing or filling large glasses or bowls.

### XL-Size

XL faucets are the largest and most stylish type of faucets available, for use with over countertop basins.



Nu basin mixers



Nu basin mixer in chrome

**Compatibility with different basins**  
(basin models and basin installation types)



**XS-Size**  
Fit for over  
countertop basins.



**S-Size**  
Fit for medium / large  
wall-hung or countertop  
basins.



**M-Size**  
Fit for standard /  
medium sized wall-hung  
or countertop basins.



**L-Size**  
Fit for standard wall-  
hung, countertop or  
undercountertop basins.



**XL-Size**  
Fit for compact,  
ultra-compact or  
small countertop or  
undercountertop basins.

## Lasting Performance

### Easy to clean

The durable chrome finish of Roca faucets is enhanced by the innovative EverShine® electrolytic coating system. This technology ensures that the faucets retain their shine over time, making them easier to clean and maintain.



Ona Floorstanding bath-shower column in chrome



Ona basin mixer in matt black

**Durability**

Roca's exclusive ceramic cartridge allows for smooth and precise operation, backed by the guarantee of one million opening and closing cycles.

**Comfort**

Softurn® technology offers exceptional control, accuracy and convenience when adjusting water flow and temperature. A noise reduction system integrated into the cartridges limits the noise of the water.

## Premium Finishes

Premium raw materials and finishes ensure that faucets are both high quality and durable, and Roca offers a variety of aesthetic and functional solutions for bathrooms and kitchens. Advanced coatings provide exceptional durability and ease of maintenance, while a choice of matt or glossy finishes offers versatile design options that enhance the overall look and feel of any room.



Ona Basin Mixer in brushed brass





Targa basin mixers

**Everlux**

Sophisticated, exclusive, and fashionable coating affords distinction and uniqueness to the bathroom. This sustainable, purely physical technique does not require harmful chemicals or generate water pollution during its production process. An extra layer on top of the chrome, based on very hard metals, ensures the surface is extraordinarily resistant to scratches and cleaning products.

**Evershine**

A high-quality chrome outer layer ensures a lasting shine and facilitates easy cleaning. The Evershine electrolytic coating reduces limescale deposits and provides protection against corrosion and scratches.

### **Matt finishes**

Polyester thermosetting powder coating made from polyester resins provides resistance to external agents, UV and corrosion. Matt black and white finishes, offer a sleek and modern touch, creating a bold contrast or a clean, understated elegance.



Ona Basin Mixer in matt black



Nu Basin Mixer in mint green

**Glossy finishes**

With bold colours including regal cobalt blue, dynamic mint green, vibrant honey yellow, stylish titanium black and glossy white, as well as classic chrome, glossy finishes allow for creative expression and add a fun, contemporary flair to any bathroom.

## Comfort and Protection

With comfort and safety in the bathroom of paramount importance, advanced technologies are designed to enhance the showering experience. Advanced thermostatic mixers offer precise water temperature control, quickly reaching and maintaining the ideal temperature, while special technology minimises the risk of scalding from hot water or surfaces. These innovations ensure a comfortable, safe and enjoyable shower.

### SafeTouch®

SafeTouch® technology ensures that the surface of thermostatic faucets remains cool to the touch, even when the water is hot. This clever design eliminates the risk of burns and adds an extra layer of safety, making every shower experience both comfortable and safe.



Thermostatic Shower Column Index-T Switch



Safety 38° Thermostatic T-2000 mixer

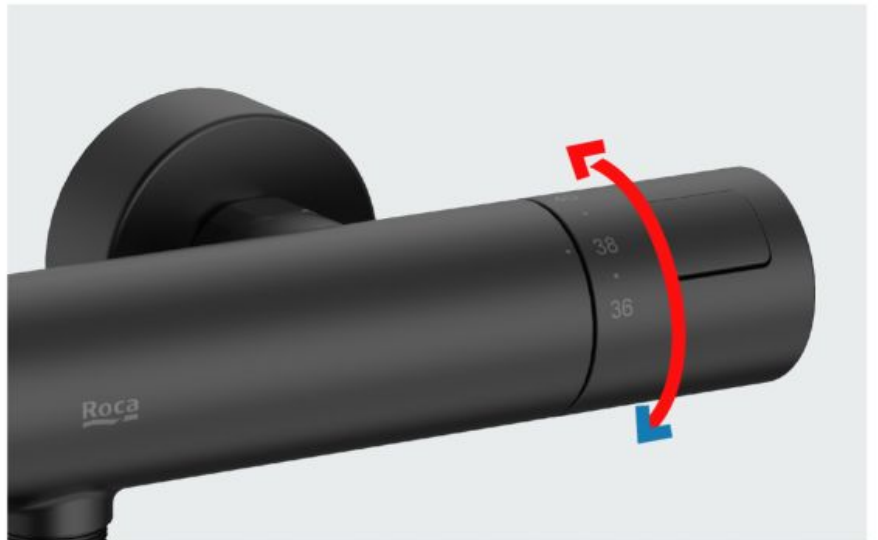

Quick Reaction® Thermostatic T-500 mixer

### **Safe temperature**

The Safety 38° system features a safety mechanism that prevents the water temperature from exceeding 38°C. This feature built into Roca's thermostatic mixers ensures a safe and comfortable experience, avoiding the possibility of scalding and providing peace of mind.

### **Instant Comfort**

Quick Reaction® technology ensures that thermostatic mixers reach the perfect water temperature in less than 3 seconds. Once the desired temperature is reached, it is maintained consistently, providing a stable and enjoyable shower experience with no fluctuations.

## The Ultimate Shower Experience

To enhance the shower experience, Roca offers a wide range of handshower models, each with water jet options that can be customized to suit individual preferences. From a gentle mist to a powerful spray, these features ensure the perfect balance of water flow and pressure, complete with anti-limescale treatment for easy maintenance.

### **Effortless maintenance**

Handshowers feature anti-limescale systems designed to easily prevent and remove limescale build-up. Incorporating soft materials into the jets, these systems ensure effective maintenance, increasing the durability and performance of the handshower over time.



Raindream shower head, rain function



Plenum Shower Kit, 3 functions

### **Sensory experience**

Modern shower systems are designed to offer a range of comforting and revitalising sensations through different water jet options.

#### **Rain**

Fine jets of water gently cover the body, creating a soothing, relaxing sensation.

#### **Tonic**

Intermittent jets form a bubble-like effect, enveloping the body in luxurious comfort.

#### **Pulse**

Intense, pulsating jets provide a refreshing and invigorating massage.

#### **Micro-Bubble**

Soft micro-bubbles deep cleanse the skin deeply, ideal for face washing and gentle care.

## Solutions for public spaces

Roca offers a range of innovative solutions for public spaces that focus on hygiene, water efficiency and accessibility. From self-closing faucets that conserve water to timed models that ensure precise flow control, these products are designed to withstand intensive use while reducing water waste. Additionally, ergonomic options ensure comfort and ease of use for individuals with reduced mobility.

### **Automatic shut-off**

Self-closing faucets are designed for maximum convenience and efficiency. Intuitive and easy to use, these faucets are operated by pressing the control button to start the water flow, which stops automatically after a short time. This solution helps to save water and reduce costs.



Electronic basin faucet L20-E





Electronic basin faucet Loft-E

### **Accessible Design**

Designed for people with reduced mobility, the Access collection combines ergonomic design with versatility and elegance. Crafted with a focus on quality, functionality and comfort, these faucets feature larger levers for easier use.



# Basin Area

Roca faucets combine functionality with stylish design to complement any bathroom. Featuring cutting-edge technology for improved water and energy efficiency, convenience and comfort, they transform any bathroom experience. With an extensive range of models from modern to traditional styles, there's a perfect fitting to suit every taste.

**Sustainability  
and safety are  
integrated into  
every faucet**



## Key Benefits

---

**Durability.** Exclusive ceramic cartridge, which allows a soft and precise operation, with the guarantee of one million opening and closing movements.

**Water savings.** Latest generation of flow limiters to 5 L/min, regardless of the pressure.

**Homogeneous flow.** Aerators with excellent aerated jet quality, even under complex pressure conditions. They come with anti-limescale protection for easy cleaning and maintenance.

**Range.** Four heights for basin faucets (S, M, L, and XL in one piece) to provide greater user-friendliness.

**Acoustic control.** Sound reduction system integrated in the cartridges and faucets to limit the noise of the water.

**Particle filter.** Protective filters included in the aerators that stop any particles coming through from the mains.

**Energy savings.** Cold water frontal opening that avoids unnecessary energy use, providing up to 45% more energy savings than conventional faucets.

## Finishes

---

### Everlux

Sophisticated, exclusive, and fashionable coating affords distinction and uniqueness to the bathroom. This sustainable, purely physical technique does not require harmful chemicals or generate water pollution during its production process. An extra layer on top of the chrome, based on very hard metals, ensures the surface is extraordinarily resistant to scratches and cleaning products.

### Evershine

A high-quality chrome outer layer guarantees a permanent shine and makes cleaning easier.

### Matt finishes

Polyester thermosetting powder coating based on polyester resins, resistant to external agents, UV radiation and corrosion.

# Insignia



Featuring an ergonomic design with organic lines and a slim side handle, Insignia's elegant finishes adds a touch of sophistication to the bathroom.

     	      <p>Basin mixer with smooth body, flexible supply hoses and click-clack waste. Cold Start. M-Size.</p> <p><b>A5A323AC00</b></p>	      <p>Basin mixer with pop-up waste and flexible supply hoses. Cold Start. M-Size.</p> <p><b>A5A333AC00</b></p>
     	      <p>Basin mixer with smooth body and flexible supply hoses. Cold Start. Click clack waste not included. M-Size.</p> <p><b>A5A3B3A..0</b></p>	      <p>Basin mixer with pop-up waste and flexible supply hoses. Cold Start. XL-Size.</p> <p><b>A5A343AC00</b></p>
     	      <p>Basin mixer with smooth body, flexible supply hoses and click-clack waste. Cold Start. XL-Size.</p> <p><b>A5A3A3AC00</b></p>	      <p>Basin mixer with smooth body and flexible supply hoses. Cold Start. Click clack waste not included. XL-Size.</p> <p><b>A5A3C3A..0</b></p>
     	      <p>Built-in basin mixer. Universal built-in body required A525220603. Pop-up waste not included.</p> <p><b>A5A353A..0</b></p>	      <p>To be completed with: Built-in universal body for the installation of built-in basin mixers.</p> <p><b>A5252206..</b></p>
     	      <p>Bidet mixer with pop-up waste and flexible supply hoses. Cold Start.</p> <p><b>A5A603AC00</b></p>	      <p>Bidet mixer with smooth body and flexible supply hoses. Cold Start.</p> <p><b>A5A6A3A..0</b></p>



### Benefits

One million cycles	Cold Start	Evershine	SafeTouch
Flow Rate 5L/min	Softurn	Security 38°	Quick Reaction

### Finishes

- CO Chrome
- CN Titanium Black
- RG Rose Gold
- NM Brushed Black



Replace (..) in the product reference with the code of the chosen finish.





Deck-mounted bath-shower mixer with 130 mm central spout, hand-shower and 1.70 m flexible shower hose.

**A5A183AC00**



Built-in bath-shower mixer with automatic diverter (2 ways). RocaBox required A525869403.

**A5A0B3A..0**

To be completed with: Universal RocaBox.

**A525869403**



Built-in bath or shower mixer (1 way). RocaBox required A525869403.

**A5A2B3A..0**

To be completed with: Universal RocaBox.

**A525869403**



Built-in thermostatic bath-shower mixer with diverter-flow regulator. RocaBox required A525869403.

**A5A0C3A ..0**

To be completed with: Universal RocaBox.

**A525869403**



Built-in thermostatic bath or shower mixer (1 way). RocaBox required A525869403.

**A5A2C3A..0**

To be completed with: Universal RocaBox.

**A525869403**



Built-in bath-shower mixer (3 ways).

**A5A2I3AC00**



Wall-mounted bath spout.

**A5A0703..0**



# L90



Robust and urban, L90 faucets play with fundamental geometric shapes to create a striking and modern design.

	    		    		    
<p>Basin mixer with pop-up waste and flexible supply hoses. Cold Start. M-Size.</p> <p><b>A5A3E01C00</b></p>	<p>Basin mixer with smooth body, click-clack waste and flexible supply hoses. Cold Start. M-Size.</p> <p><b>A5A3F01C00</b></p>	<p>Basin mixer with integrated lateral handle, pop-up waste and flexible supply hoses. Cold Start. L-Size.</p> <p><b>A5A4001C00</b></p>			
	    			    	
<p>Basin mixer with pop-up waste and flexible supply hoses. Cold Start. XL-Size.</p> <p><b>A5A3G01C00</b></p>	<p>Twin-lever basin mixer with deck-mounted lateral handles - 3 holes-, pop-up waste and flexible supply hoses. S-Size.</p> <p><b>A5A4420C00</b></p>	<p>Built-in basin mixer. Universal built-in body required A525220603 Pop-up waste not included.</p> <p><b>A5A3L20C00</b></p> <p>To be completed with: Universal built-in body for the installation of built-in basin mixers.</p> <p><b>A525220603</b></p>			
	    			    	
<p>Bidet mixer with pop-up waste and flexible supply hoses.</p> <p><b>A5A6001C00</b></p>	<p>Bidet mixer with integrated lateral handle, pop-up waste and flexible supply hoses. Cold Start.</p> <p><b>A5A6301C00</b></p>	<p>Wall-mounted bath-shower mixer with automatic diverter.</p> <p><b>A5A0D01C00</b></p>			



### Benefits

One million cycles	Cold Start	Evershine	Flow Rate	Softurn

### Finishes

- CO Chrome



Replace (..) in the product reference with the code of the chosen finish.



Wall-mounted shower mixer.

**A5A216DC00**



Deck-mounted twin-lever bath-shower mixer with 197 mm central spout, diverter, hand-shower and 1.60 m flexible shower hose.

**A5A0901C00**



Deck-mounted bath-shower mixer with 197 mm spout, diverter, hand-shower and 1.60 m flexible shower hose.

**A5A9801C00**



Deck-mounted bath-shower mixer with 130 mm spout, diverter, hand-shower and flexible shower hose.

**A5A9901C00**



Floorstanding bath-shower mixer with automatic diverter, hand-shower, 1.50 m flexible shower hose and integrated hand-shower wall bracket.

**A5A2701C00**



Built-in bath-shower mixer with automatic diverter (2 ways). RocaBox required A525869403.

**A5A0B01C00**



Built-in bath or shower mixer (1 way). RocaBox required A525869403.

**A5A2B01C00**



Built-in bath-shower mixer (3 ways).

**A5A2I01C00**



Built-in thermostatic bath-shower mixer with diverter-flow regulator. RocaBox required A525869403.

**A5A0I01C00**

# L90C



## Benefits



One million cycles



Cold Start



Evershine



Flow Rate



Softurn

## Finishes

● C0 Chrome

Unified Water Label  5 l/min

Unified Water Label  8 l/min

Replace (..) in the product reference with the code of the chosen finish.

With its robust and striking geometric shapes, this more compact version echoes the urban aesthetic of its counterpart.



Basin mixer with pop-up waste and flexible supply hoses. Cold Start. S-Size.

**A5A3A01C00**



Basin mixer with smooth body, flexible supply hoses and click-clack waste. Cold Start. S-Size.

**A5A3B01C00**

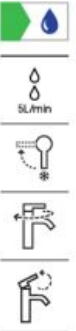

Basin mixer with pop-up waste and flexible supply hoses. Cold Start. M-Size.

**A5A3D01C00**



Basin mixer with smooth body, flexible supply hoses and click-clack waste. Cold Start. M-Size.

**A5A3C01C00**



Bidet mixer with pop-up waste and flexible supply hoses. Cold Start.

**A5A6A01C00**

# Pals





Fusing technology and design, Pals incorporates a very slim and charismatic joystick control to deliver water with total precision.



Basin mixer with joystick handle, pop-up waste and flexible supply hoses. M-Size.

**A5A306DC00**



Basin mixer with joystick handle, smooth body, flexible supply hoses and click-clack waste. M-Size.

**A5A326DC00**



Basin mixer with joystick handle, smooth body, flexible supply hoses and click-clack waste. XL-Size.

**A5A376DC00**



Built-in basin mixer. Universal built-in body required A525220603. Pop-up waste not included.

**A5A356DC00**

To be completed with:  
Universal built-in body for the installation of built-in basin mixers.

**A525220603**



Bidet mixer with joystick handle, flexible supply hoses and pop-up waste.

**A5A606DC00**





Wall-mounted bath-shower mixer with automatic diverter.

**A5A026DC00**



**Benefits**

		
Evershine	Flow Rate	Joystick-Turn

**Finishes**

- C0 Chrome



Replace (..) in the product reference with the code of the chosen finish.



Wall-mounted shower mixer.

**A5A216DC00**

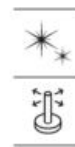

Floorstanding bath-shower mixer with automatic diverter, hand-shower, 1.75 m flexible shower hose and integrated hand-shower wall bracket.

**A5A276DC00**



Deck-mounted bath-shower mixer with central spout, diverter and hand-shower.

**A5A986DC00**



Built-in bath-shower mixer with automatic diverter (2 ways). RocaBox required.

**A525869403.**



Built-in bath or shower mixer (1 way). RocaBox required A525869403.

**A5A2B6DC00**

# Loft



A modern reinterpretation of the double-lever handle results in the elegant and contemporary Loft collection.



Twin-lever basin mixer with pop-up waste and flexible supply hoses. L-Size.

**A5A3043C00**



Twin-lever basin mixer with central swivel spout, pop-up waste and flexible supply hoses. L-Size.

**A5A4443C00**



Built-in twin-lever basin mixer with 190 mm spout.

**A5A4743C00**

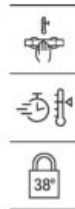

Loft-T

Wall-mounted thermostatic bath-shower mixer with diverter-flow regulator, hand-shower, 1.70 m flexible shower hose and swivel hand-shower wall bracket.

**A5A1143C00**



Loft-T

Wall-mounted thermostatic shower mixer, hand-shower, 1.50 m flexible shower hose and swivel hand-shower wall bracket.

**A5A1343C00**

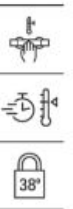

Loft-T

Built-in thermostatic bath-shower mixer with diverter-flow regulator. RocaBox required A525869403.

**A5A0643C00**



### Benefits

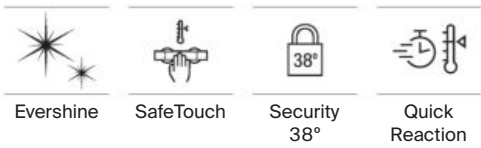

### Finishes

● C0 Chrome

Replace (..) in the product reference with the code of the chosen finish.

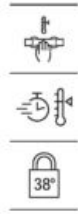

Loft-T  
Built-in thermostatic bath-shower mixer with diverter-flow regulator.

**A5A0743C00**

Deck-mounted twin-lever bath-shower mixer with 197 mm central spout, diverter, hand-shower and 1.60 m flexible shower hose.

**A5A0943C00**

Floorstanding twin-lever bath-shower mixer with automatic diverter with retention, hand-shower, 1.75 m flexible shower hose and floor pillar leg.

**A5A2743C00**



Built-in diverter for bath or shower (2 ways). 1/2".

**A5A9043C00**

Built-in diverter for bath or shower (3 ways). 1/2".

**A5A9143C00**



Built-in valve. 1/2" F index (cold).

**A5A1543C00**

Built-in valve. 1/2" C index (warm).

**A5A1843C00**



Built-in valve. 3/4" F index (cold).

**A5A1643C00**

Built-in valve. 3/4" C index (warm).

**A5A1943C00**

# Carmen





Classical inspiration and a vintage spirit live at the heart of Carmen delicate faucets for sophisticated and emphatically classical interiors.

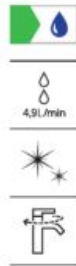

Basin mixer with smooth body, click-clack waste and flexible supply hoses. S-Size.

**A5A304BC00**

Basin mixer with smooth body and flexible supply hoses. S-Size.

**A5A314BC00**

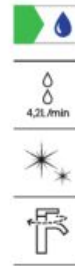

Twin-lever basin mixer with smooth body, click-clack waste and flexible supply hoses. M-Size.

**A5A3A4BC00**



Twin-lever basin mixer with smooth body, swivel spout, click-clack waste and flexible supply hoses. L-Size.

**A5A384BC00**



Twin-lever basin mixer with deck-mounted lateral handles - 3 holes-, click-clack waste and flexible supply hoses. M-Size.

**A5A444BC00**

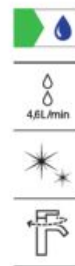

Built-in twin-lever basin mixer. Waste kit not included.

**A5A474BC00**

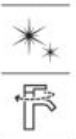

Twin-lever bidet mixer with click-clack waste and flexible supply hoses.

**A5A6A4BC00**



Wall-mounted twin-lever bath-shower mixer with manual diverter, hand-shower, 1.50 m flexible shower hose and swivel hand-shower wall bracket.

**A5A014BC00**



Deck-mounted bath-shower mixer with central spout, diverter and hand-shower.

**A5A094BC00**



Deck-mounted bath-shower mixer with central spout, diverter and hand-shower.

**A5A094BC00**



**Benefits**

Evershine	Flow Rate	Softurn

**Finishes**

● C0 Chrome

Unified Water Label	4.2 l/min
Unified Water Label	4.5 l/min
Unified Water Label	4.6 l/min
Unified Water Label	4.8 l/min
Unified Water Label	4.9 l/min

Replace (..) in the product reference with the code of the chosen finish.



Floorstanding twin-lever bath-shower mixer with manual diverter, hand-shower, 1.50 m flexible shower hose and floor pillar leg.

**A5A274BC00**



Built-in valve.

**A5A154BC00**

To be completed with:  
Universal RocaBox.

● **A525869403**

# Nu



The Nu collection represents a pure visual expression and a synthesis of essential design: form, shape and colour. Derived from the French word 'Nu' meaning naked, this collection distils design to its most fundamental essence, presenting a timeless simplicity.

Featuring three different handle designs - Pin, Dome, and Stripes - the Nu collection is available in six glossy colours that reflect Roca's Mediterranean influence: green, blue, yellow, black, white and chrome. This range of options allows for extensive creativity and personalisation in the bathroom space.

With its streamlined, sculpted design and a body diameter of 35 millimetres, the thinnest Roca has produced has ever produced, the Nu collection integrates ingenuity, sustainability and quality, offering an exciting new perspective in faucet design.









01

02

04

03

- 01 3 different handles: Pin, Dome and Stripes.
- 02 Hidden details: blue / red indicators shape a smiley face.
- 03 Smooth and precise operation, with a long-term guarantee.
- 04 A variety of styles and finishes let you create a highly personalized bathroom interior.

Personalisation is at the heart of this new collection. There are no limits or preconceived ideas. Everyone can mix and match colours and shapes to suit their style, adapting it to small domestic spaces or larger commercial settings. The full range of six colours is available on faucets designed for washbasins, bathtubs, and bidets, as well as wall-mounted faucets for showers and washbasins, offering endless combinations.

**Benefits**

Flow Rate	Softturn	One million cycles	Cold Start

**Finishes**









C0 Chrome	CN Everlux Titanium Black	P3 Glossy White
P2 Mint Green	P1 Honey Yellow	P0 Cobalt Blue



Replace (..) in the product reference with the code of the chosen finish.



# Nu

 <p>Basin mixer with pop-up waste, flexible supply hoses and Pin handle. S-Size.</p> <p><b>A5A303FC00</b></p>	 <p>Basin mixer with smooth body, flexible supply hoses and Pin handle. S-Size.</p> <p><b>A5A323F.0</b></p>	 <p>Basin mixer with smooth body, flexible supply hoses and Dome handle. S-Size.</p> <p><b>A5A3Y3F.0</b></p>
 <p>Basin mixer with smooth body, flexible supply hoses and Stripes handle. S-Size.</p> <p><b>A5A3B3F.0</b></p>	 <p>Basin mixer with smooth body, flexible supply hoses and Pin handle. XL-Size.</p> <p><b>A5A343F.0</b></p>	 <p>Basin mixer with smooth body, flexible supply hoses and Dome handle. XL-Size.</p> <p><b>A5A3X3F.0</b></p>
 <p>Basin mixer with smooth body, flexible supply hoses and Stripes handle. XL-Size.</p> <p><b>A5A3C3F.0</b></p>	 <p>Basin mixer with lateral handle, smooth body, flexible supply hoses and Pin handle. L-Size.</p> <p><b>A5A4A3F.0</b></p>	 <p>Basin mixer with deck-mounted lateral handle, 2 holes, smooth body, flexible supply hoses and Dome handle. L-Size.</p> <p><b>A5A3W3F.0</b></p>



Basin mixer with deck-mounted lateral handle, 2 holes, smooth body, flexible supply hoses and Stripes handle. L-Size.

**A5A3D3F.0**



Twin-lever basin mixer with deck-mounted lateral handles, 3 holes, smooth body, flexible supply hoses and Dome handle. L-Size.

**A5A3V3F.0**



Twin-lever basin mixer with deck-mounted lateral handles, 3 holes, smooth body, flexible supply hoses and Stripes handle. L-Size.

**A5A3E3F.0**



Bidet mixer with smooth body, flexible supply hoses and Pin handle.

**A5A623F.0**



Bidet mixer with smooth body, flexible supply hoses and Dome handle. **A5A6X3F.0**



Bidet mixer with smooth body, flexible supply hoses and Stripes handle.

**A5A6C3F.0**



Wall-mounted bath-shower mixer with automatic diverter and Pin handle.

**A5A023F.0**



Wall-mounted bath-shower mixer and Pin handle.

**A5A213F.0**



Built-in basin mixer with Pin handle. Built-in body A5E3502..0 required.

**A5A353F.0**





Wall-mounted bath spout.

**A5A083F.0**



Built-in bath-shower mixer with automatic diverter (2 ways) and Pin handle.

**A5A0B3F.0**

To be completed with:  
Universal RocaBox.



**A525869403**



Built-in shower mixer (1 way) and Pin handle.

**A5A2B3F.0**

To be completed with:  
Universal RocaBox.



**A525869403**









# Naia



United  
Water Label  5 l/min

Inspired by minimalist lines and sophisticated finishes, Naia combines cylindrical and square shapes to create a balanced aesthetic.

 <p>Basin mixer with pop-up waste and flexible supply hoses. Cold Start. S-Size.</p> <p><b>A5A3096C00</b></p>	 <p>Basin mixer with smooth body, flexible supply hoses and click-clack waste. Cold Start. S-Size.</p> <p><b>A5A3296C00</b></p> <p>Basin mixer with smooth body and flexible supply hoses. Cold Start. Click clack waste not included. S-Size</p> <p><b>A5A3A96..0</b></p>	 <p>Basin mixer with pop-up waste and flexible supply hoses. Cold Start. M-Size.</p> <p><b>A5A3396C00</b></p>
 <p>Basin mixer with smooth body, click-clack waste and flexible supply hoses. Cold Start. M-Size.</p> <p><b>A5A3996C00</b></p>	 <p>Basin mixer with pop-up waste and flexible supply hoses. Cold Start. L-Size.</p> <p><b>A5A3D96C00</b></p>	 <p>Basin mixer with pop-up waste and flexible supply hoses. Cold Start. XL-Size.</p> <p><b>A5A3496C00</b></p>



**Benefits**

Flow Rate	Softurn	One million cycles	Cold Start	Evershine

**Finishes**

- C0 Chrome
- CN Titanium Black
- RG Rose Gold
- NM Brushed Black



Replace (..) in the product reference with the code of the chosen finish.



Basin mixer with smooth body, click-clack waste and flexible supply hoses. Cold Start. XL-Size.

**A5A3796C00**

Basin mixer with smooth body and flexible supply hoses. Cold Start. Click clack waste not included. XL-Size.

**A5A3B96..0**



Built-in basin mixer. Universal built-in body required A525220603. Pop-up waste not included.

**A5A3596..0**

To be completed with:  
Built-in universal body for the installation of built-in basin mixers.

**A5252206..**

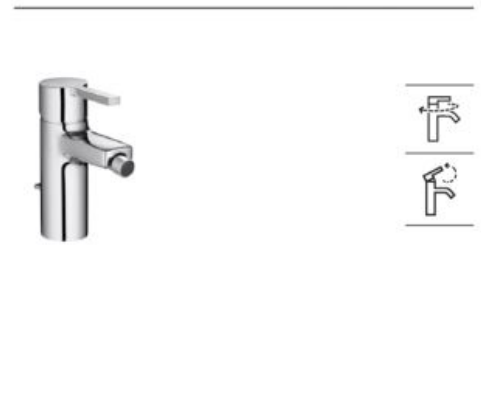

Bidet mixer with pop-up waste and flexible supply hoses.

**A5A6096C00**

Bidet mixer with smooth body and flexible supply hoses. Click-clack waste not included.

**A5A6A96..0**



Wall-mounted bath-shower mixer with automatic diverter.

**A5A0296..0**



Wall-mounted shower mixer.

**A5A2196..0**



Built-in bath-shower mixer with automatic diverter (2 ways). RocaBox required A525869403.

**A5A0B96..0**

To be completed with:  
Universal RocaBox.

**A525869403**

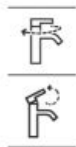

Built-in bath or shower mixer (1 way). RocaBox required A525869403.

**A5A2B96..0**

To be completed with:  
Universal RocaBox.

**A525869403**



Built-in bath-shower mixer (3 ways).

**A5A2I96C00**



Built-in bath-shower mixer with automatic diverter (2 ways). RocaBox required A525869403.

**A5A0I96C00**



# Targa





The redesigned Targa collection inspires a lifestyle of sustainable elegance. Designed with meticulous attention to detail, its sleek, slender silhouette and clean, straight lines exude an air of modern refinement.









01

02

03

04

- 01 Cold start opening system.
- 02 Comfort height.
- 03 Multiple finishes.
- 04 Flow rate.

Redefining style. Targa faucets have undergone a transformation. The revamped collection boasts a commanding silhouette characterised by bold lines that capture a pure and minimalist aesthetic.

**Benefits**

 5L/min				
Flow Rate	Softurn	One million cycles	Cold Start	Evershine







**Finishes**

 CO Chrome	 NB Matt Black	 BO Matt White
 SM Stainless Steel Finish	 VA Brushed Brass	

Unified Water Label  5 l/min

Unified Water Label  8 l/min

Replace (..) in the product reference with the code of the chosen finish.

		
<p>Basin mixer with pop-up waste and flexible supply hoses. S-Size.</p> <p><b>A5A305FC00</b></p> <p>●</p>	<p>Basin mixer with smooth body and flexible supply hoses. S-Size.</p> <p><b>A5A325F..0</b></p> <p>● ● ● ● ●</p>	<p>Basin mixer with smooth body and flexible supply hoses. XL-Size.</p> <p><b>A5A345F..0</b></p> <p>● ● ● ● ●</p>
		
<p>Basin mixer with lateral handle, smooth body and flexible supply hoses. L-Size.</p> <p><b>A5A405F..0</b></p> <p>● ● ● ● ●</p>	<p>Built-in basin mixer.</p> <p><b>A5A355F..0</b></p> <p>● ● ● ● ●</p>	<p>Bidet mixer with pop-up waste and flexible supply hoses.</p> <p><b>A5A605FC00</b></p> <p>●</p>
		
<p>Bidet mixer with smooth body and flexible supply hoses.</p> <p><b>A5A625F..0</b></p> <p>● ● ● ● ●</p>	<p>Wall-mounted shower mixer.</p> <p><b>A5A215F..0</b></p> <p>● ● ● ● ●</p>	<p>Wall-mounted shower mixer.</p> <p><b>A5A215F..0</b></p> <p>● ● ● ● ●</p>



### Benefits



### Finishes

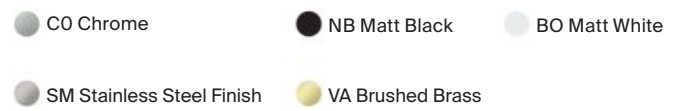

Replace (..) in the product reference with the code of the chosen finish.

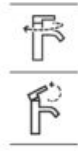

Built-in shower mixer (1 way).

**A5A2B5F.0**

RocaBox required.

**A525869403**



Built-in bath-shower mixer with automatic diverter (2 ways).

**A5A0B5F.0**

RocaBox required.

**A525869403**



# Ona





A versatile, balanced and slender collection, Ona combines functionality, design and modern finishes, making it easy to combine with a variety of contemporary products and interiors.





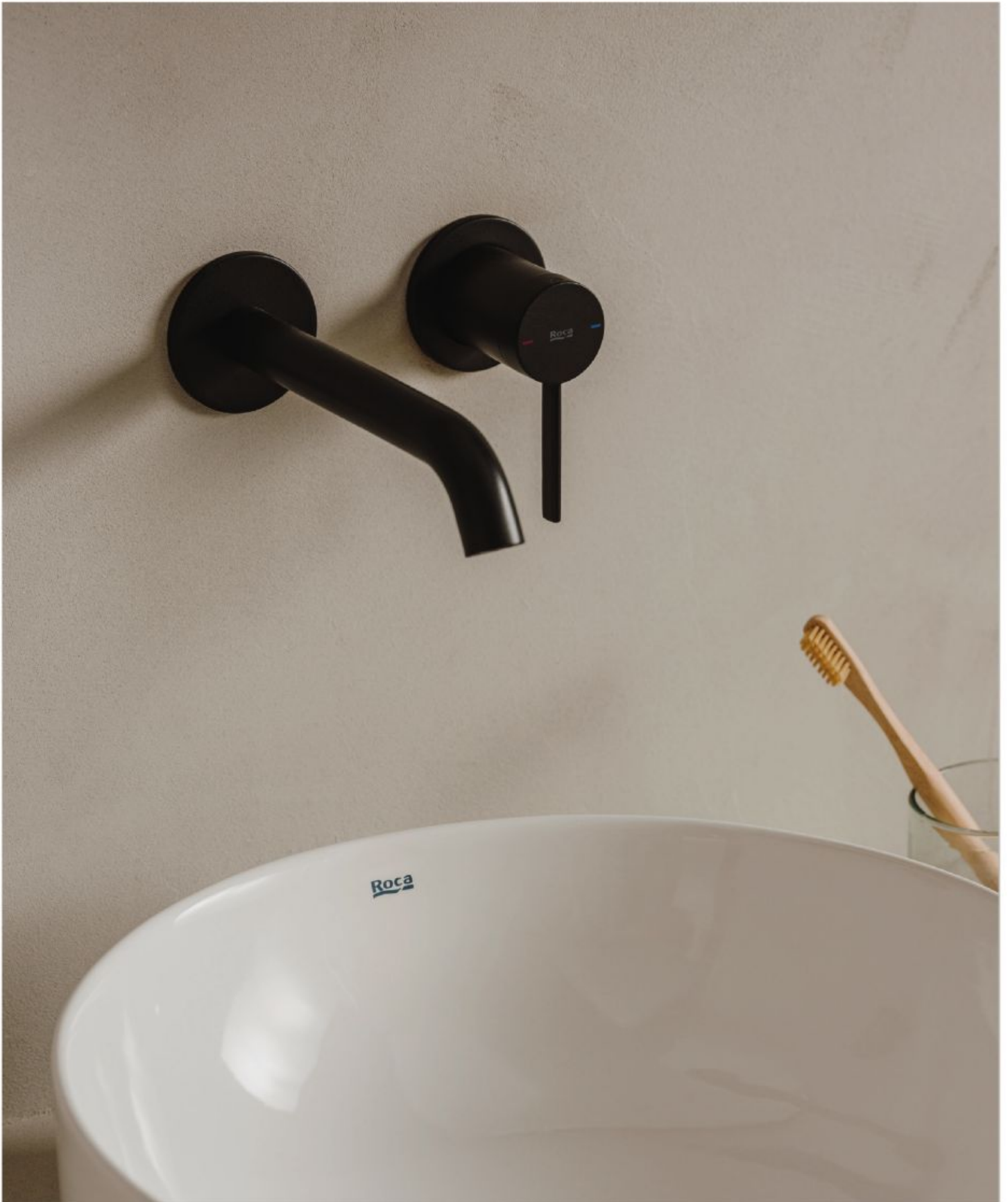



01

02

03

04

05

- 01 Cold start and 5L/min flow restriction.
- 02 High tech ceramic cartridge.
- 03 38mm diameter body, integrated aerator.
- 04 Four different basin mixer sizes.
- 05 Up to 4 coatings available.

Ona bathroom faucets are available in four finishes offering the possibility to customise the bathroom space. The chromed finish features Evershine electrolytic coating, that guarantees market-leading anticorrosion, brightness and superficial uniformity with anti-scratch properties. The titanium black and rose gold feature the sophisticated Everlux PVD technology, creating a fine but extraordinarily durable and scratch-resistant finish. Finally, a more classic choice for matt black completes the series.

#### Benefits

 5L/min				
Flow Rate	Softurn	One million cycles	Cold Start	Evershine

#### Finishes

C0 Chrome	CN Titanium Black	RG Rose Gold
VA Brushed Brass	SM Stainless Steel Finish	NB Matt Black
BO Matt White		



Replace (..) in the product reference with the code of the chosen finish.



Basin mixer with pop-up waste and flexible supply hoses. Cold Start. S-Size.

**A5A309E..0**



Basin mixer with smooth body, click-clack waste and flexible supply hoses. Cold Start. S-Size.

**A5A3A9E..0**



Basin mixer with click-clack waste and flexible supply hoses. Cold Start. M-Size.

**A5A3C9E..0**



Basin mixer with lateral handle, smooth body, click-clack waste and flexible supply hoses. Cold Start. L-Size.

**A5A4A9E..0**



Basin mixer with smooth body, click-clack waste and flexible supply hoses. Cold Start. XL-Size.

**A5A349E..0**



Basin mixer with deck-mounted lateral handle - 2 holes -, smooth body, click-clack waste and flexible supply hoses. L-Size.

**A5A389E..0**



Basin mixer with deck-mounted lateral handle - 2 holes -, smooth body, click-clack waste and flexible supply hoses. XL-Size.

**A5A399E..0**



Built-in basin mixer. Built-in body required A5E3501C00. Pop-up waste not included.

**A5A359E..0**

Built-in body required:

**A5E3501..0**



Built-in basin mixer. Pop-up waste not included.

**A5A459E..0**

Built-in body required:

**A5E3501..0**











**Benefits**

 5L/min				
Flow Rate	Softurn	One million cycles	Cold Start	Evershine

**Finishes**

 C0 Chrome	 CN Titanium Black	 RG Rose Gold
 VA Brushed Brass	 SM Stainless Steel Finish	 NB Matt Black
 BO Matt White		



Replace (..) in the product reference with the code of the chosen finish.



Bidet mixer with pop-up waste and flexible supply hoses.

**A5A609E..0**

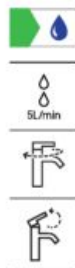

Bidet mixer with smooth body and 94 flexible supply hoses.

**A5A629E..0**



Wall-mounted bath-shower mixer with automatic diverter.

**A5A029E..0**



Wall-mounted shower mixer.

**A5A219E..0**



Floorstanding bath-shower column with automatic diverter, hand-shower, 1.7 m flexible shower hose, adjustable hand-shower bracket and vertical supply columns. Built-in body A525231803 required.

**A5A279E..0**



Built-in bath-shower mixer with automatic diverter (2 ways). RocaBox required A525869403.

**A5A0B9E..0**

To be completed with: Universal RocaBox.

**A525869403**



Built-in bath or shower mixer (1 way). RocaBox required A525869403.

**A5A2B9E..0**

To be completed with: Universal RocaBox.

**A525869403**



# Atlas





With a solid and well-proportioned design, Atlas features compact and resolute shapes that blend into any modern bathroom setting.



Basin mixer with pop-up waste and flexible supply hoses. Cold Start. S-Size.

**A5A3090C00**



Basin mixer with retractable chain and flexible supply hoses. Cold Start. S-Size.

**A5A3190C00**



Basin mixer with smooth body and flexible supply hoses. Cold Start. Click clack waste not included. S-Size.

**A5A3290C00**



Basin mixer with smooth body and flexible supply hoses. Cold Start. Click clack waste not included. M-Size.

**A5A3990C00**



Basin mixer with smooth body and flexible supply hoses. Cold Start. Click clack waste not included. L-Size.

**A5A3D90C00**



Basin mixer with smooth body and flexible supply hoses. Cold Start. Click clack waste not included. XL-Size.

**A5A3790C00**



Built-in basin mixer. Universal built-in body required A525220603. Pop-up waste not included.

**A5A3590C00**

To be completed with: Universal built-in body for the installation of built-in basin mixers.

**A525220603**



Bidet mixer with pop-up waste and flexible supply hoses.

**A5A6090C00**



Bidet mixer with retractable chain and flexible supply hoses.

**A5A6190C00**



### Benefits

 5L/min				
Flow Rate	Softurn	One million cycles	Cold Start	Evershine

### Finishes

● C0 Chrome

Replace (..) in the product reference with the code of the chosen finish.



Wall-mounted bath-shower mixer with automatic diverter, hand-shower and flexible shower hose.

**A5A0190C00**

Wall-mounted bath-shower mixer with automatic diverter.

**A5A0290C00**



Wall-mounted shower mixer with Stella hand-shower, 1.50 m flexible shower hose and swivel hand-shower wall bracket.

**A5A2090C00**

Wall-mounted shower mixer.

**A5A2190C00**

Optional:  
Adaptable shelf.

**A5B4961TP0**



Floorstanding bath-shower column with automatic diverter, hand-shower, 1.75 m flexible shower hose and integrated hand-shower bracket.

**A5A2790C00**



Built-in bath-shower mixer with automatic diverter (2 ways). RocaBox required A525869403.

**A5A0B90C00**

To be completed with:  
Universal RocaBox.

**A525869403**



Built-in bath-shower mixer with automatic diverter (2 ways). RocaBox required A525869403.

**A5A0690C00**



Built-in bath or shower mixer (1 way). RocaBox required A525869403.

**A5A2B90C00**

To be completed with:  
Universal RocaBox.

**A525869403**



Built-in bath or shower mixer (1 way). Includes the built-in subset and the trim plate. Complete set.

**A5A2290C00**



Built-in bath-shower mixer (3 ways).

**A5A2190C00**



Built-in bath-shower mixer with automatic diverter (2 ways). Includes the built-in subset and the trim plate. Complete set.

**A5A0190C00**

# Monodin



United  
Water Label  5 l/min

The smooth curves and ergonomic handle emphasise the basics and provide a simple, yet aesthetically-pleasing solution.



Basin mixer with pop-up waste and flexible supply hoses. Cold Start. S-Size.

**A5A3098C00**



Basin mixer with retractable chain and flexible supply hoses. Cold Start. S-Size.

**A5A3198C00**



Basin mixer with smooth body and flexible supply hoses. Cold Start. Click clack waste not included. S-Size.

**A5A3298C00**



Bidet mixer with pop-up waste and flexible supply hoses.

**A5A6098C00**



Bidet mixer with chain connector and flexible supply hoses.

**A5A6198C00**



Built-in basin mixer. Universal built-in body required A525220603. Pop-up waste not included.

**A5A3L98C00**

To be completed with: Universal built-in body for the installation of built-in basin mixers.

**A525220603**



Wall-mounted bath-shower mixer with automatic diverter.

**A5A0298C00**



Wall-mounted shower mixer.

**A5A2198C00**







Built-in bath-shower mixer with automatic diverter (2 ways). Includes the built-in subset and the trim plate. Complete set.

**A5A0698C00**



### Benefits

 5L/min				
Flow Rate	Softurn	One million cycles	Cold Start	Evershine

### Finishes

● C0 Chrome

Replace (..) in the product reference with the code of the chosen finish.

# Monodin

---



Built-in bath or shower mixer (1 way).  
Includes the built-in subset and the  
trim plate. Complete set.

**A5A2298C00**



# Cala





Cala's symmetrical spout and handle result in a contemporary and elegant faucet with exceptional functionality and ergonomic comfort.





### Benefits

				
Flow Rate	Softurn	One million cycles	Cold Start	Evershine

### Finishes

- C0 Chrome
- NB Matt Black
- BO Matt White



Replace (..) in the product reference with the code of the chosen finish.



Basin mixer with pop-up waste and flexible supply hoses. Cold Start. S-Size.

**A5A306EC00**



Basin mixer with retractable chain and flexible supply hoses. Cold Start. S-Size.

**A5A316EC00**



Basin mixer with smooth body and flexible supply hoses. Cold Start. S-Size.

**A5A326E..0**



Basin mixer with smooth body and flexible supply hoses. Cold Start. Click clack waste not included. M-Size.

**A5A336EC00**

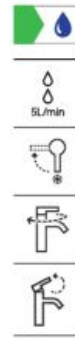

Basin mixer with smooth body and flexible supply hoses. Cold Start. Click clack waste not included. XL-Size.

**A5A346E..0**



Built-in basin mixer. Universal built-in body required A525220603.

**A5A356E..0**

To be completed with: Universal built-in body for the installation of built-in basin mixers.

**A5252206..**



Bidet mixer with pop-up waste and flexible supply hoses.

**A5A606EC00**



Bidet mixer with chain connector and flexible supply hoses.

**A5A616EC00**







Bidet mixer with smooth body and flexible supply hoses.

**A5A626E..0**



**Benefits**

 5L/min				
Flow Rate	Softurn	One million cycles	Cold Start	Evershine

**Finishes**

- C0 Chrome
- NB Matt Black
- BO Matt White

Replace (..) in the product reference with the code of the chosen finish.



Wall-mounted bath-shower mixer with automatic diverter.

**A5A026E..0**



Wall-mounted shower mixer.

**A5A216E..0**



Built-in bath-shower mixer with automatic diverter (2 ways). Includes the built-in subset and the trim plate. Complete set.

**A5A066E..0**

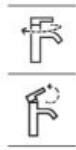

Built-in bath or shower mixer (1 way). Includes the built-in subset and the trim plate. Complete set.

**A5A226E..0**



Built-in bath-shower mixer with automatic diverter (2 ways). RocaBox required A525869403.

**A5A0B6EC00**

To be completed with: Universal RocaBox.

**A525869403**



# L20



Paying homage to the circle and its smooth forms, L20's neutral geometry easily adapts to any bathroom style.



Basin mixer with pop-up waste and flexible supply hoses. Cold Start. S-Size.

**A5A3I09C00**

Basin mixer with plastic pop-up waste and flexible supply hoses. Cold Start. S-Size.

**A5A3N09C00**



Basin mixer with retractable chain and flexible supply hoses. Cold Start. S-Size.

**A5A3J09C00**



Basin mixer with smooth body and flexible supply hoses. Cold Start. Click clack waste not included. S-Size.

**A5A3K09.0**



Basin mixer with smooth body and flexible supply hoses. Cold Start. Click clack waste not included. M-Size.

**A5A3B09C00**



Basin mixer with pop-up waste and flexible supply hoses. Cold Start. XL-Size.

**A5A3C09C00**

Basin mixer with plastic pop-up waste and flexible supply hoses. Cold Start. XL-Size.

**A5A3P09C00**



Basin mixer with smooth body and flexible supply hoses. Cold Start. Click clack waste not included. XL-Size.

**A5A3H09NB0**



Built-in basin mixer. Universal built-in body A5252206.. required. Click clack waste not included.

**A5A3L09.0**

To be completed with: Universal built-in body for the installation of built-in basin mixers.

**A5252206..**



Bidet mixer with pop-up waste and flexible supply hoses.

**A5A6A09C00**





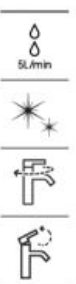

Bidet mixer with chain connector and flexible supply hoses.

**A5A6B09C00**





**Benefits**

 5L/min				
Flow Rate	Softurn	One million cycles	Cold Start	Evershine

**Finishes**

- CO Chrome
- NB Matt Black

Replace (..) in the product reference with the code of the chosen finish.





Bidet mixer with smooth body and flexible supply hoses. Waste kit not included.

**A5A6C09NB0**



Wall-mounted bath-shower mixer with automatic diverter with retention, hand-shower, 1.70 m metal flexible shower hose and swivel hand-shower wall bracket.

**A5A0109C02**



Wall-mounted bath-shower mixer with automatic diverter with retention, Stella 100/3F hand-shower, 1.75 m satin PVC flexible shower hose and fixed hand-shower wall bracket.

**A5A0109NB4**



Wall-mounted shower mixer with hand-shower, 1.50 m flexible shower hose and swivel hand-shower wall bracket.

**A5A2009C02**

Wall-mounted shower mixer.

**A5A2009C00**



Wall-mounted bath-shower mixer with Stella 100/3F hand-shower, 1.75 m satin PVC shower flexible hose and fixed hand-shower wall bracket.

**A5A2009NB4**



Built-in bath-shower mixer with automatic diverter (2 ways). Includes the built-in subset and the trim plate. Complete set.

**A5A0A09..0**



Built-in bath or shower mixer (1 way). Includes the built-in subset and the trim plate. Complete set.

**A5A2A09..0**

# Victoria Plus







Revitalising one of Roca's most versatile collections with a more stylised and slender design, Victoria Plus incorporates subtle details for a contemporary update.





### Benefits

 5L/min				
Flow Rate	Softurn	One million cycles	Cold Start	Evershine















































### Finishes

-  CO Chrome



Replace (..) in the product reference with the code of the chosen finish.

# Victoria Plus

	    		    		    
<p>Basin mixer with pop-up waste and flexible supply hoses. Cold Start. S-Size.</p> <p><b>A5A304FC00</b></p>	<p>Basin mixer with smooth body and flexible supply hoses. Cold Start. S-Size.</p> <p><b>A5A324FC00</b></p>	<p>Basin mixer with smooth body, click-clack waste and flexible supply hoses. Cold Start. S-Size.</p> <p><b>A5A3A4FC00</b></p>			
	    		    		    
<p>Basin mixer with pop up waste and flexible supply hoses. Cold Start. M-Size.</p> <p><b>A5A334FC00</b></p>	<p>Basin mixer with smooth body, click-clack waste and flexible supply hoses. Cold Start. M-Size.</p> <p><b>A5A3B4FC00</b></p>	<p>Basin mixer with lateral handle, pop up waste and flexible supply hoses. Cold Start. L-Size.</p> <p><b>A5A404FC00</b></p>			
	    		    		    
<p>Basin mixer with lateral handle, smooth body with click-clack waste and flexible supply hoses. Cold Start. L-Size.</p> <p><b>A5A4A4FC00</b></p>	<p>Basin mixer with smooth body, click-clack waste and flexible supply hoses. Cold Start. XL-Size.</p> <p><b>A5A3C4FC00</b></p>	<p>Single-lever bidet mixer with pop up waste and flexible supply hoses.</p> <p><b>A5A604FC00</b></p>			



**Benefits**

 5L/min				
Flow Rate	Softurn	One million cycles	Cold Start	Evershine

**Finishes**

-  CO Chrome



Replace (..) in the product reference with the code of the chosen finish.



Single-lever bidet mixer with smooth body and flexible supply hoses.

**A5A624FC00**



Wall-mounted bath-shower mixer with automatic diverter, Natura hand-shower, 1.70 m flexible shower hose and fixed hand-shower wall bracket.

**A5A014FC00**



Wall-mounted shower mixer with Natura hand-shower, 1.50 m flexible shower hose and hand-shower wall bracket.

**A5A204FC00**



Wall-mounted bath-shower mixer with automatic diverter with retention.

**A5A024FC00**



Wall-mounted shower mixer.

**A5A214FC00**



Built-in bath-shower mixer with automatic diverter (2 ways). Includes the built-in subset and the trim plate. Complete set.

**A5A064FC00**



Built-in bath or shower mixer (1 way). Includes the built-in subset and the trim plate. Complete set.

**A5A224FC00**

# Victoria Pro



## Benefits



Accessibility



Softturn



One million  
cycles



Evershine

## Finishes

● C0 Chrome



Replace (..) in the product reference with the code of the chosen finish.



Redefining accessibility in bathroom design, Victoria Pro features an ergonomic handle design with a sleek, modern aesthetic. Thoughtfully crafted to enhance comfort and usability for all.



Basin mixer with smooth body and flexible supply hoses. Elbow handle for people with reduced mobility. S-Size.

**A5A325GC00**



Basin mixer with smooth body and flexible supply hoses. Elbow open handle for people with reduced mobility. S-Size.

**A5A3D5GC00**



Wall-mounted basin or kitchen mixer with swivel spout. Handle for people with reduced mobility.

**A5A765GC00**



Kitchen mixer with retractable swivel spout, rinse spray function and flexible supply hoses.

**A5A8E5GC00**



Wall-mounted bath-shower mixer with automatic diverter, hand-shower, 1.70 m flexible hose and swivel wall bracket. Handle for people with reduced mobility.

**A5A015GC00**



Wall-mounted shower mixer with hand-shower, 1.70 m flexible hose and swivel wall bracket. Handle for people with reduced mobility.

**A5A205GC00**

# Victoria



## Benefits



Softurn



One million  
cycles



Cold Start



Evershine

## Finishes

● C0 Chrome

Replace (..) in the product reference with the code of the chosen finish.

The Victoria collection is all about versatility. With subtly rounded contours and no sharp edges or straight lines, the compact and ergonomic design ensures overall comfort.



Basin mixer with pop-up waste and flexible supply hoses. XS-Size.

**A5A3025C00**



Basin mixer with chain connector and flexible supply hoses. XS-Size.

**A5A3125C00**



Bidet mixer with pop-up waste and flexible supply hoses.

**A5A6025C00**



Bidet mixer with chain connector and flexible supply hoses.

**A5A6125C00**



Wall-mounted bath-shower mixer.

**A5A1725C00**

# Brava



A revamped classic, Brava maintains its contemporary appeal with warm and simple lines in a twin-lever configuration.



Twin-lever basin mixer with smooth body and flexible supply hoses. Waste kit not included. S-Size.

**A5A318EC00**



Twin-lever basin mixer with swivel spout, pop-up waste and flexible supply hoses. M-Size.

**A5A368EC00**



Basin mixer with swivel spout and flexible supply hoses. M-Size.

**A5A518EC00**



Basin pillar faucet (blue index). XS-Size.

**A5A428EC00**

Basin pillar faucet (red index). XS-Size.

**A5A438EC00**



Built-in basin faucet (blue index).

**A5A788EC00**

Built-in basin faucet (red index).

**A5A798EC00**



Twin-lever bidet mixer with smooth body and flexible supply hoses. Waste kit not included.

**A5A618EC00**



Bidet pillar faucet (blue index).

**A5A658EC00**

Bidet pillar faucet (red index).

**A5A668EC00**



Wall-mounted bath-shower mixer with automatic diverter.

**A5A018EC00**



Wall-mounted shower mixer.

**A5A208EC00**



### Benefits



Evershine

### Finishes

● C0 Chrome

Replace (..) in the product reference with the code of the chosen finish.



Angle shut-off cock for washing machine or dishwasher. 1/2" x 3/4".

**A5A808EC00**

1/2" x 3/4" two ways angle shut-off cock for washing machine or dishwasher.

**A5A178EC00**

Built-in valve for welding. 1/2". Blue index.

**A5A158EC00**

Built-in valve for welding. 1/2". Red index.

**A5A188EC00**



Built-in valve for welding. 3/4". Blue index.

**A5A168EC00**

Built-in valve for welding. 3/4". Red index.

**A5A198EC00**

Built-in diverter (2 ways) for bath or shower. 1/2".

**A526223510**





# Shower and Bath Shower Area

Designed to suit every preference and bathroom style, Roca's world of versatile shower solutions combines functionality with elegance. From the personalised comfort of hand showers with adjustable spray settings to the indulgence of overhead rain showers, these solutions are made to deliver an exceptional experience. Thermostatic mixers ensure precise temperature control, while smart showers offer programmable features for improved water and energy efficiency. Sleek floorstanding mixers and shower columns bring modern sophistication, with finishes including chrome and matt black adding a sophisticated touch to any space.



<b>Smart Shower</b>	110
<b>Thermostatic Mixers</b>	116
<b>Roca Box</b>	120
<b>Deck-mounted &amp; Floorstanding mixers</b>	126
<b>Thermostatic Shower Columns</b>	132
<b>Shower Columns</b>	138
<b>Handshowers</b>	146
<b>Shower Heads</b>	154
<b>Complements</b>	160

# Smart Shower



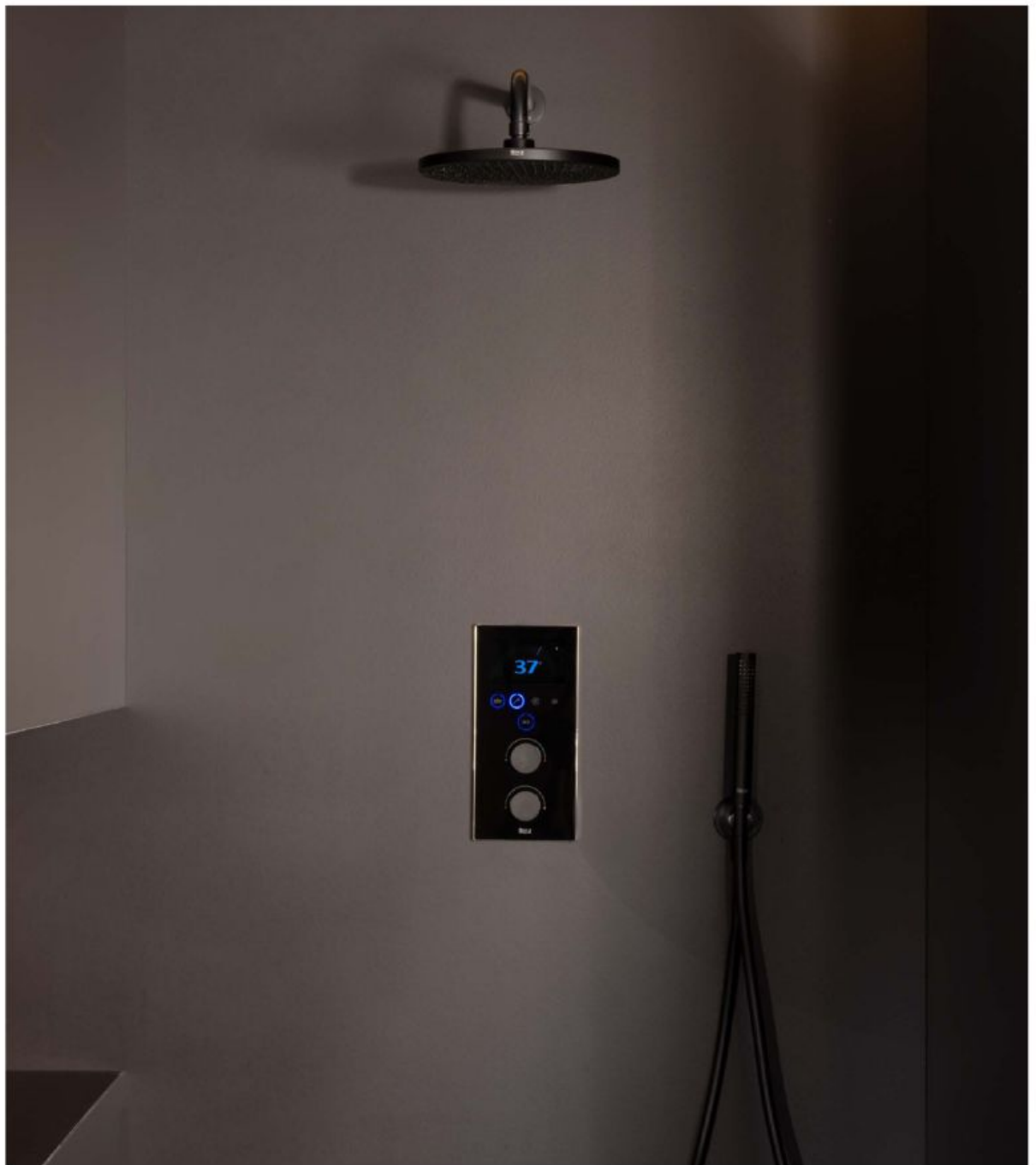

**Roca's Smart Shower delivers an exceptional experience with adjustable temperature, water flow and personalised profiles tailored to each family member. It offers the convenience of starting, stopping and resuming your shower with consistent water conditions through intuitive use of controls. The system can also be seamlessly configured and controlled via the Roca Connect mobile app, allowing for greater comfort and customisation with each use.**



**Upon waking up, the Smart Shower awaits at the perfect temperature.**

## Key Benefits

---

**Slim design.** With a minimalist 12 mm profile, the control panel hardly protrudes from the wall.

**Advanced design.** 4.3" colour display, temperature controls and high-precision flow rate, and touch buttons with integrated lighting.

**User-friendly design.** With capacitive technology and ergonomically designed rotating controls, it is exceptionally easy to use. Its illuminated buttons light up when touched, making it intuitive to use for everyone, including children and the elderly.

**Self-cleaning.** A cleaning programme activates all water outlets and rinses them with an intermittent high-pressure stream of water to effectively remove limescale and impurities that can accumulate in pipes and jets.

**Fully customisable.** Users can save their preferences for temperature, flow rate and water outlets in personalised profiles to enhance their daily showering experience.

**Safety.** Child Mode locks the display to prevent children from changing settings.

**Convenience.** The Smart Shower can be activated remotely through a mobile app, effortlessly programming the shower and filling the bath with water at the desired temperature. Users can also easily also monitor water and energy consumptions.

**Efficiency.** The shower also manages the bath water, keeping it at the perfect temperature and turning off the tap when finished.

**Water and Energy Savings.** Pause mode saves water while lathering, and usage statistics help monitor and reduce consumption, ensuring consistent water conditions when showering resumes.



01

02

04

03

- 01 **Advanced design 4.3" colour display, temperature controls and high-precision flow rate, and touch buttons with integrated lighting..**
- 02 **Fully customizable.**
- 03 **Easy installation.**
- 04 **Ultrafine design.**

The Smart Shower provides consumption statistics, the display also has a Pause Mode that shuts off the water flow to let you lather up without wasting huge amounts of water. Moreover, when you resume your shower, you will continue enjoying the same water conditions.

Replace (..) in the product reference with the code of the chosen finish.





## Smart Shower

Electronic thermostatic mixer for bath-shower. Mains operated at 230V. Includes power source, control panel and installation kit.

**A5A104AC00**



## Pack Smart Shower 2 ways

Pack Smart Shower: Smart Shower A5A104AC00, Raindream

300 x 300 mm shower head A5B2750C00, Square straight wall arm L400 mm A5B0950C00, Stick Square Handshower A5B9L61C00,

1.75 m shower hose in satin PVC A5B2116C00, bracket for Handshower with water inlet A5B0850C00.

**A5D114AC00**



## Pack Smart Shower 3 ways

Pack Smart Wellness: Smart Shower A5A104AC00, Raindream

350 x 350 mm shower head A5B3250C00, Puzzle adjustable jet (x3) A5B3778C00, Stick Square Handshower A5B9L61C00, 1.75 m shower hose in satin PVC A5B2116C00, bracket for Handshower with water inlet A5B0850C00.

**A5D124AC00**

# Thermostatic Mixers





**Roca's thermostatic mixers are designed to ensure maximum safety and comfort for everyday use. They provide a consistent water temperature and flow rate, adapting seamlessly to changes in water pressure. With advanced safety features, including temperature control to prevent scalding and cool-to-touch surfaces, these solutions ensure a safe and comfortable showering experience every time.**



**Universal  
shower solutions  
designed for any  
bathroom space  
and user needs**

## Key Benefits

---

**Instant Comfort.** Quick Reaction® technology ensures the desired temperature is reached in less than three seconds and keeps it constant to save water and energy.

**Precision.** Ergonomic controls that enable quick and precise temperature selection with one simple movement.

**Safety.** Safe Touch® technology prevents overheating of the faucet body, avoiding burns when touching the metal parts.

**Safe Temperature.** The Safety 38° system features an anti-scalding mechanism, preventing water from exceeding 38°C.

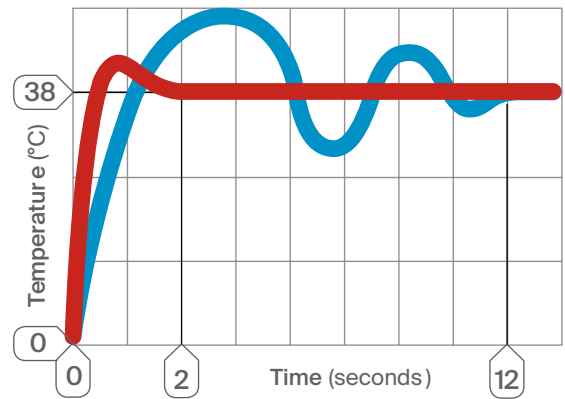

### Temperature adjustment

- Thermostatic faucet
- Conventional faucet

# RocaBox



**RocaBox is a versatile universal shower valve housing unit, compatible with a wide range of built-in manual and thermostatic mixers. Compact and easy to install, it fits seamlessly into both stud and solid walls, making it the ideal solution for bathrooms with limited space.**

## Key Benefits

---

**Universal.** Compatible with both manual and thermostatic built-in mixers, supporting single or dual outlets.

**Compact.** The most space-efficient universal body available, it requires a minimum installation depth of just 70 mm (including stud wall measurement).

**Versatile Outlets.** Can be configured with 1 or 2 outlets, allowing for multiple combinations.

**Easy Access & Maintenance.** Once installed, the RocaBox can be easily accessed and maintained. Shower mixers can also be changed easily during future bathroom upgrades and renovations, saving time and reducing costs in commercial environments.

**Protective Cover Plate.** A protective cover plate that shields the unit from dust and dirt during construction.

**Design.** A double sealed design offers superior water tightness.

**Compatibility.** Compatible with various Roca built-in mixers, including both manual and thermostatic models.

**Noise Reduction.** A sound-absorbing back plate that reduces noise levels during operation.

**Flexible Installation.** Can be installed in both solid and stud walls.

**WRAS Approved.** Certified as a WRAS approved product, ensuring quality and safety.

**5-Year Guarantee.** Comes with a 5-year warranty for peace of mind.

**Note:** The RocaBox is a housing unit only. It must be installed with compatible built-in mixers and cover plates, which are sold separately.



01

02

06

05

04

03

- 01 Up 2 outlets can be operated at the same time
- 02 Thermostatic mixers that allow to get the required temperature with a quick reaction saving water & energy
- 03 Rocabox compatible.
- 04 Material: Zamak
- 05 Anti-scalding protection at 38°C
- 06 Switch on-off technology for an intuitive & simple outlet selection with flow regulation.

Finishes

- C0 Chrome
- CN Titanium Black
- RG Rose Gold
- VA Brushed Brass
- SM Stainless Steel Finish
- NB Matt Black
- BO Matt White

Benefits

One million cycles	Cold Start	Evershine	SafeTouch
Flow Rate	Softurn	Security 38°	Quick Reaction
			On-Off Switch Technology

Replace (..) in the product reference with the code of the chosen finish.



# Thermostatic Mixers



T-Multi (2 ways)

Built-in thermostatic shower mixer (2 ways).

**A5A204A..0**

Built-in body required

**A5E204AC00**



T-Multi (2 ways)

Built-in thermostatic shower mixer (2 ways) with handshower, swivel wall bracket and 1.70 m PVC shower flexible hose.

**A5A214A..0**

Built-in body required

**A5E214AC00**



T-Multi (3 ways)

Built-in thermostatic shower mixer (3 ways).

**A5A224A..0**

Built-in body required

**A5E224AC00**



T-Multi (3 ways)

Built-in thermostatic shower mixer (3 ways) with handshower, swivel wall bracket and 1.70 m PVC shower flexible hose.

**A5A234A..0**

Built-in body required

**A5E234AC00**



T-Multi (2 ways)

Built-in thermostatic shower mixer (2 ways) with handshower, swivel wall bracket, 1.70 m PVC shower flexible hose and bath spout.

**A5A244A..0**

Built-in body required

**A5E244AC00**

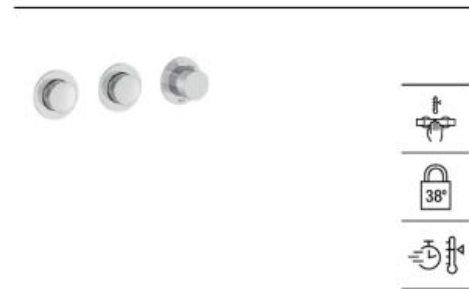

T-Multi Switch (2 ways)

Switch built-in thermostatic shower mixer (2 ways).

**A5A704A..0**

Built-in body required

**A5E704AC00**

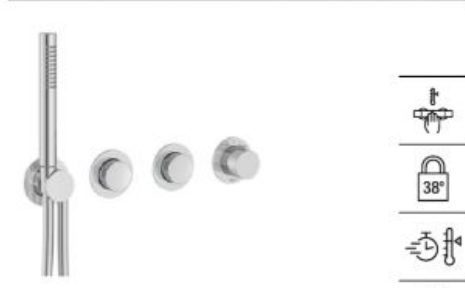

T-Multi Switch (2 ways)

Switch built-in thermostatic shower mixer (2 ways) with handshower, swivel wall bracket and 1.70 m PVC shower flexible hose.

**A5A714A..0**

Built-in body required

**A5E714AC00**

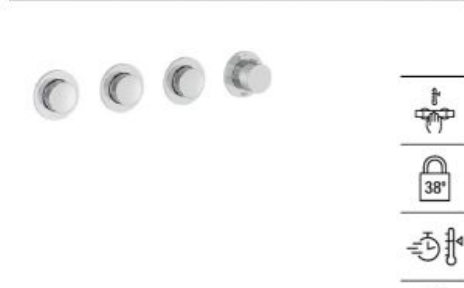

T-Multi Switch (3 ways)

Switch built-in thermostatic shower mixer (3 ways).

**A5A724A..0**

Built-in body required

**A5E724AC00**

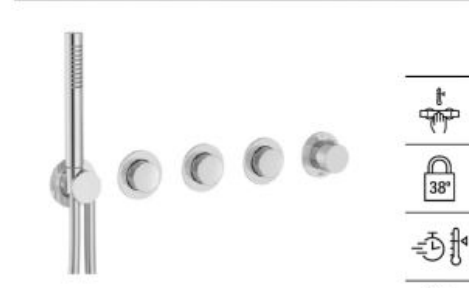

T-Multi Switch (3 ways)

Switch built-in thermostatic shower mixer (3 ways) with handshower, swivel wall bracket and 1.70 m PVC shower flexible hose.

**A5A734A..0**

Built-in body required

**A5E734AC00**



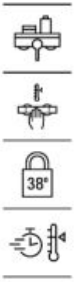
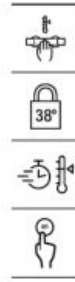
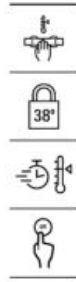

T-3000 Switch Round

Built-in thermostatic bath-shower mixer, 2-way diverter. Roca Box Universal required.

**A5A2K09..0**



T-3000 Switch Square

Basin mixer with smooth body, flexible supply hoses and Pin handle. S-Size.

**A5A2I09..0**



T-2000

Wall-mounted thermostatic bath-shower mixer with shelf, automatic diverter and retractable spout.

**A5A1288C00**



T-2000

Wall-mounted thermostatic shower mixer with shelf.

**A5A2A88C00**



T-2000

Basin mixer with smooth body, flexible supply hoses and Pin handle. S-Size

**A5A1188C00**



T-2000

Built-in thermostatic bath or shower mixer. RocaBox required A525869403.

**A5A2C88C00**

RocaBox required:

**A525869403**

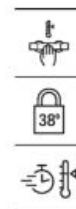

T-2000

Built-in thermostatic bath-shower mixer with diverter-flow regulator. RocaBox required A525869403.

**A5A0C88C00**

RocaBox required:

**A525869403**



T-1000 Round

Built-in thermostatic bath-shower mixer with automatic diverter.

**A5A1E2E..0**



T-1000 Round

Built-in thermostatic shower mixer.

**A5A142E..0**



# Thermostatic Mixers



T-1000 Round

Built-in thermostatic bath-shower mixer with diverter-flow regulator. RocaBox required A525869403.

**A5A0D09..0**

RocaBox required:

**A525869403**



T-1000 Round

Built-in thermostatic bath or shower mixer. RocaBox required A525869403.

**A5A2E09..0**

RocaBox required:

**A525869403**



T-500

Wall-mounted thermostatic bath-shower mixer with diverter-flow regulator.

**A5A1E18..0**



T-500

Wall-mounted thermostatic shower mixer.

**A5A2E18..0**



T-500

Built-in thermostatic bath-shower mixer with automatic diverter (2 ways). Includes the built-in subset and the trim plate. Complete set.

**A5A2K18..0**



T-500

Built-in thermostatic bath-shower mixer. Includes the built-in subset and the trim plate. Complete set.

**A5A2M18C00**



T-500

Built-in thermostatic bath-shower mixer with automatic diverter (2 ways).

**A5A0C18..0**

RocaBox required:

**A525869403**



T-500

Pack. Includes: wall-mounted thermostatic shower mixer and shower set with 100 mm, 3 functions Stella Handshower, adjustable Handshower bracket and 1.70 m flexible hose.

**A5D2E18C00**



T-500

Pack. Includes: wall-mounted thermostatic shower mixer and shower set with 100 mm, three functions Stella Handshower, 700 mm slide bar with adjustable Handshower bracket and 1.70 m flexible shower hose.

**A5D2F18C00**



# Deck-mounted & Floorstanding mixers





**Deck-mounted mixers are installed onto the bath, single-lever operated mixers allow you to control the water flow and temperature using a single handle. Bath-shower mixers include a shower hose, handset, and bracket.**

## Deck-mounted mixers



### Insignia

Deck-mounted bath-shower mixer with 197 mm central spout, Handshower and 1.70 m flexible shower hose.

**A5A093AC00**



### Insignia

Deck-mounted bath-shower mixer with 130 mm central spout, Handshower and 1.70 m flexible shower hose.

**A5A183AC00**



### L90

Deck-mounted twin-lever bath-shower mixer with 197 mm central spout, diverter, Handshower and 1.60 m flexible shower hose.

**A5A0901C00**



### L90

Deck-mounted bath-shower mixer with 197 mm spout, diverter, Handshower and 1.60 m flexible shower hose.

**A5A9801C00**



### L90

Deck-mounted bath-shower mixer with 130 mm spout, diverter, Handshower and flexible shower hose.

**A5A9901C00**

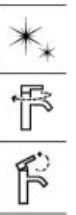

### Pals

Deck-mounted bath-shower mixer with central spout, diverter and Handshower.

**A5A986DC00**



### Loft

Deck-mounted twin-lever bath-shower mixer with 197 mm central spout, diverter, Handshower and 1.60 m flexible shower hose.

**A5A0943C00**



### Carmen

Deck-mounted bath-shower mixer with central spout, diverter and Handshower.

**A5A094BC00**

# Bath Spouts



Insignia  
Wall-mounted bath spout.  
**A5A0703CO0**



Nu  
Wall-mounted bath spout.  
● **A5A083F..0**



Round  
Wall-mounted bath spout.  
● ● **A525310800** ●



Square  
Wall-mounted bath spout.  
**A5253089..**









Ona  
Wall-mounted bath spout.  
● ● ● ● **A5A0803..0** ● ● ● ● ● ●



**Benefits**

		
Evershine	Softurn	One million cycles

**Finishes**

 CO Chrome	 CN Titanium Black	 RG Rose Gold
 VA Brushed Brass	 SM Stainless Steel Finish	 NB Matt Black
 BO Matt White		

Replace (..) in the product reference with the code of the chosen finish.



## Floorstanding mixers



L90

Floorstanding bath-shower mixer with automatic diverter, Handshower, 1.50 m flexible shower hose and integrated Handshower wall bracket.

**A5A2701C00**

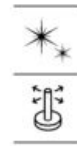

Pals

Floorstanding bath-shower mixer with automatic diverter, Handshower, 1.75 m flexible shower hose and integrated Handshower wall bracket.

**A5A276DC00**



Loft

Floorstanding twin-lever bath-shower mixer with automatic diverter with retention, Handshower, 1.75 m flexible shower hose and floor pillar leg.

**A5A2743C00**



Carmen

Floorstanding twin-lever bath-shower mixer with manual diverter, Handshower, 1.50 m flexible shower hose and floor pillar leg.

**A5A274BC00**



Ona

Floorstanding bath-shower column with automatic diverter, Handshower, 1.7 m flexible shower hose, adjustable Handshower bracket and vertical supply columns. Built-in body A525231803 required.

**A5A279E..0**



Atlas

Floorstanding bath-shower column with automatic diverter, Handshower, 1.75 m flexible shower hose and integrated Handshower bracket.

**A5A2790C00**

# Thermostatic Shower Columns



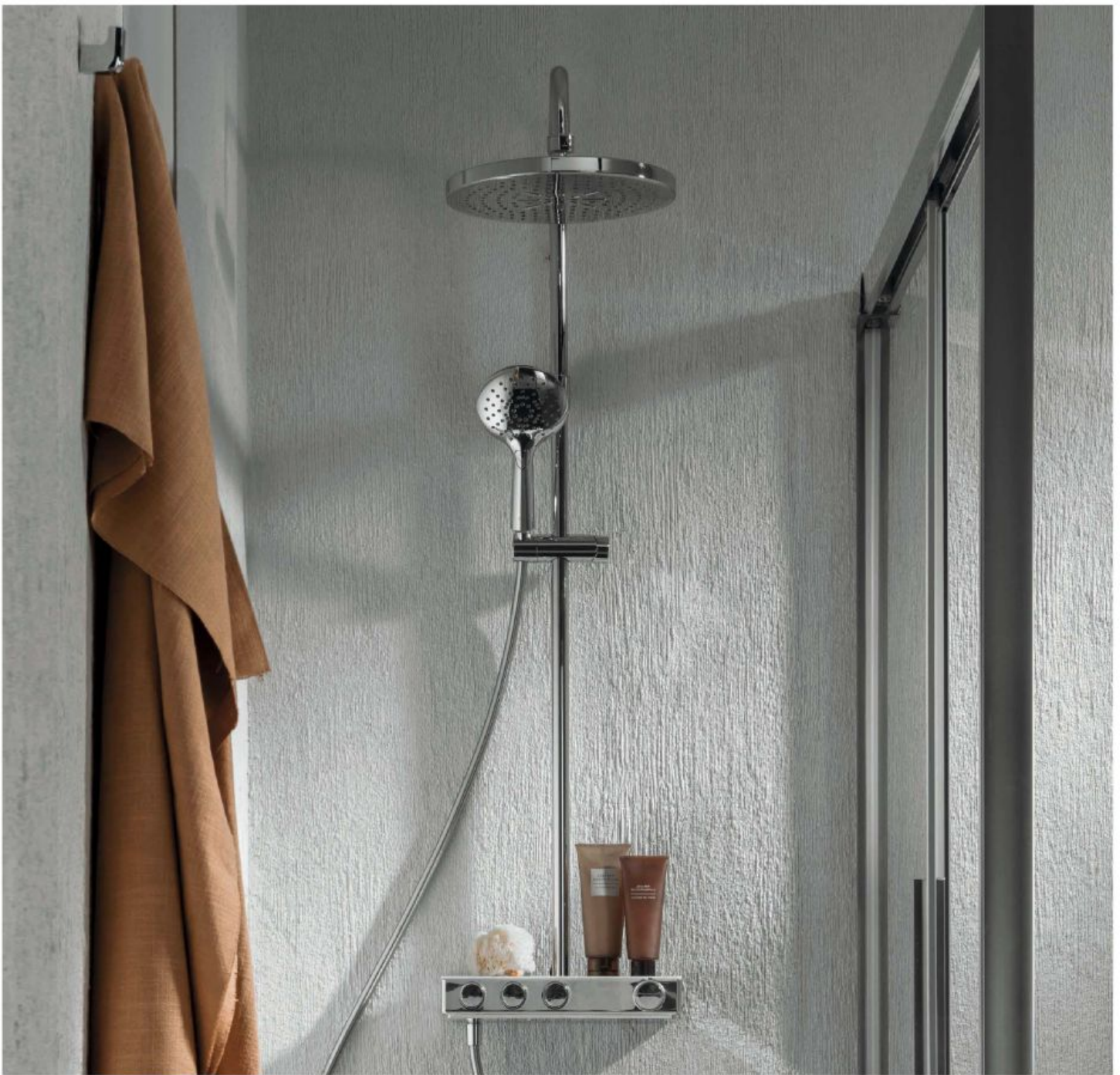

**Thermostatic hydromassage shower columns combine sleek design with advanced technology for a luxurious and safe showering experience. Intuitive button controls allow for easy adjustment, while thermostatic technology maintains a constant water temperature even when pressure changes. SafeTouch® technology features prevent surfaces from overheating, making it ideal for all ages.**



### Design and Technology

Intuitive on/off button technology including water flow adjustment. Multiple functions can be activated at the same time. 300mm head shower with 2 functions (invigorating and concentrated rain).

### Comfort

Thermostatic solutions maintain a constant water temperature and respond instantly to changes in water pressure, ensuring the required temperature is maintained. Includes shelf.

### Safety

Internal components prevent possible scalding from contact with the body. Ideal for young children or the elderly.

### Benefits

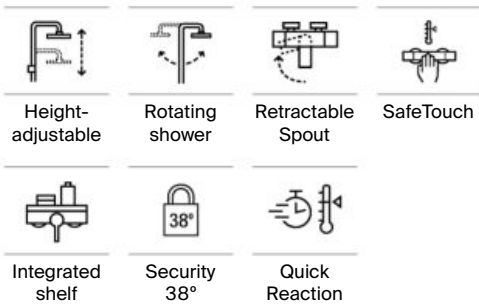

### Finishes



Replace (..) in the product reference with the code of the chosen finish.

# Thermostatic Shower Columns



**Index-T Switch 3v**

Thermostatic shower column with shelf for shower. Shower head ø300 mm with two functions, 1.50 m satin PVC shower flexible shower hose and Plenum Go 120/3F Handshower.

**A5A9J09C00**

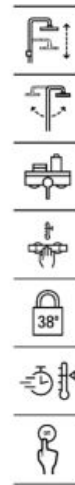

**Index-T Switch 2v**

Thermostatic shower column with shelf for shower. Adjustable height from 780 to 1130 mm and swivelling shower arm. Shower head ø250 mm, 1.50 m satin PVC shower flexible hose and Plenum Go 120/3F Handshower.

**A5A9I09C00**

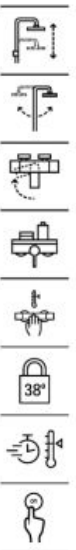

**Index-T Switch 3v bath-shower**

Thermostatic bath-shower column with shelf for shower and retractable bath spout. Adjustable height from 1320 to 1670 mm and swivelling shower arm. Shower head ø250 mm, 1.70 m satin PVC shower flexible hose and Plenum Go 120/3F Handshower.

**A5A9H09C00**

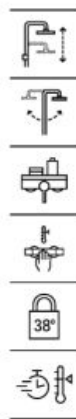

**Deck-T Square**

Thermostatic shower column with shelf, adjustable in height (800 mm to 1200 mm) and adjustable shower arm, with 360 x 240 mm shower head, ø 130 mm Handshower (four functions) on sliding support, 1.75 m satin PVC shower flexible hose and articulated Handshower bracket.

**A5A9C88C00**



**Deck-T Round**

Thermostatic shower column with shelf, adjustable in height (800 mm to 1200 mm) and adjustable shower arm, with ø 250 mm shower head, ø 130 mm Handshower (four functions) on sliding support, 1.75 m satin PVC shower flexible hose and articulated Handshower bracket.

**A5A9788C00**

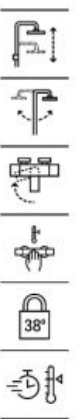

**Even-T Square bath-shower**

Thermostatic shower column, adjustable in height (1100 mm to 1500 mm) and adjustable shower arm, with 360 x 240 mm shower head, ø 100 mm Handshower (three functions) on sliding support, 1.75 m satin PVC shower flexible hose and articulated Handshower bracket.

**A5A2H2EC00**

# Thermostatic Shower Columns

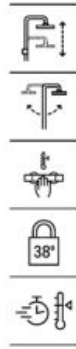

Even-T Square

Thermostatic shower column, adjustable in height (800 mm to 1175 mm) and adjustable shower arm, with 360 x 240 mm shower head, ø 100 mm Handshower (three functions) on sliding support, 1.75 m satin PVC shower flexible hose and articulated Handshower bracket.

**A5A202EC00**

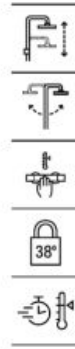

Even-T Round

Thermostatic shower column, adjustable in height (800 mm to 1175 mm) and adjustable shower arm, with ø 250 mm shower head, ø 100 mm Handshower (three functions) on sliding support, 1.75 m satin PVC shower flexible hose and articulated Handshower bracket.

**A5A9A2EC00**

Thermostatic shower column with fixed height, with ø 250 mm shower head, ø 100 mm hand shower (three functions) on sliding support, 1.75 m satin PVC shower flexible hose and articulated Handshower bracket .

**A5A9A2E..2**

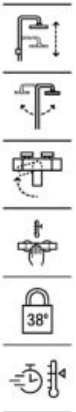

Victoria-T Plus bath-shower

Thermostatic shower column, adjustable in height (1295 mm to 1670 mm) and adjustable shower arm, with retractable spout, ø 245 mm shower head, ø 100 mm Handshower (three functions) on sliding support, 1.7 m satin PVC shower flexible hose and articulated Handshower bracket.

**A5A2J18C00**

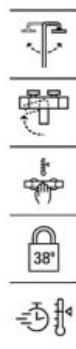

Victoria-T Basic bath-shower

Thermostatic shower column with fixed height and retractable spout, ø 200 mm shower head, ø 100 mm Handshower (one function) on sliding support, 1.7 m satin PVC shower flexible hose and articulated Handshower bracket.

**A5A2H18C00**

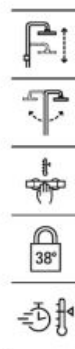

Victoria-T Plus

Thermostatic shower column, adjustable in height (800 mm to 1175 mm) and adjustable shower arm, with ø 245 mm shower head, ø 100 mm Handshower (three functions) on sliding support, 1.7 m satin PVC shower flexible hose and articulated Handshower bracket.

**A5A2F18C00**

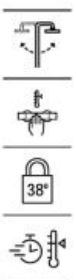

Victoria-T Basic

Thermostatic shower column with fixed height, ø 200 mm shower head, ø 100 mm Handshower (one function) on sliding support, 1.7 m satin PVC shower flexible hose and articulated Handshower bracket.

**A5A9F18..0**

# Hydromassage Columns

---



## Evolution

Thermostatic hydromassage shower column.

### **A5A9B8BC00**

Optional:

Optional installation kit, for mounting the column in a corner.

### **A525994103**

Shelf. For installation on an Essential or Evolution hydromassage shower column.

### **A5B4863TP0**



## Essential

Thermostatic hydromassage shower column.

### **A5A9A8BC00**

Optional:

Optional installation kit, for mounting the column in a corner.

### **A525994103**

Shelf. For installation on an Essential or Evolution hydromassage shower column.

### **A5B4863TP0**

# Shower Columns







**Roca's range of multifunctional shower columns are designed for reliable performance and comfort. These columns feature integrated shower heads, hand showers and various options including water jets, waterfalls and rain showers. Available in a variety of styles and configurations, they cater for a wide range of tastes and bathroom needs.**



**Benefits**

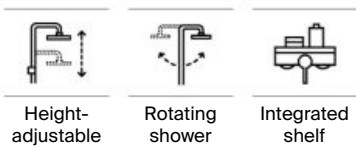

Height-adjustable

Rotating shower

Integrated shelf

**Finishes**

- CO Chrome
- CN Titanium Black
- NM Brushed Black
- NB Matt Black
- BO Matt White



Replace (..) in the product reference with the code of the chosen finish.

## Shower Columns

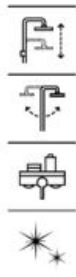

Even-M Round

Single-lever shower column with shelf, adjustable in height - 875 mm to 1275 mm - and adjustable shower arm, with  $\varnothing$  250 mm shower head,  $\varnothing$  100 mm Handshower (three functions) on sliding support, 1.75 m satin PVC shower flexible hose and articulated Handshower bracket.

**A5A9790C00**

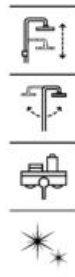

Even-M Square

Single-lever shower column with shelf, adjustable in height - 875 mm to 1275 mm - and adjustable shower arm, with  $\varnothing$  250 mm shower head,  $\varnothing$  100 mm Handshower (three functions) on sliding support, 1.75 m satin PVC shower flexible hose and articulated Handshower bracket.

**A5A9B90C00**

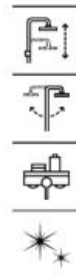

Even-M

Single-lever shower column with shelf, adjustable in height - 1253 mm to 1653 mm - and adjustable shower arm, with bath filler spout, 360 x 240 mm shower head,  $\varnothing$  100 mm Handshower (three functions) on sliding support, 1.75 m satin PVC hose and articulated Handshower bracket.

**A5A9C90C00**



L20

Single-lever shower column adjustable in height (855 mm to 1230 mm) and adjustable shower arm. Includes  $\varnothing$  254 mm shower head,  $\varnothing$  100 mm Handshower one function, 1.5 m metal hose and articulated Handshower bracket.

**A5A9709C00**



Victoria-M Plus

Single-lever shower column adjustable in height,  $\varnothing$  254 mm shower head,  $\varnothing$  100 mm Handshower (one function) and 1.5 m metal hose.

**A5A9A4FC00**



Victoria-M Basic

Single-lever shower column with fixed height,  $\varnothing$  254 mm shower head,  $\varnothing$  100 mm Handshower (one function) and 1.5 m metal hose.

**A5A974FC00**

## Shower Columns

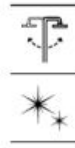
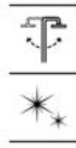

### Loft

Twin-lever thermostatic shower column with fixed height, ø 200 mm shower head, 25 x 180 mm Handshower, 1.7 m metal hose and articulated Handshower bracket.

**A5A9743C00**

### Carmen

Twin-lever thermostatic shower column with fixed height, ø 200 mm shower head, Handshower, 1.5 m metal hose and Handshower bracket.

**A5A974BC00**

### Vega Plus

Single-lever shower column adjustable in height. Shower-head ø250 mm, 1.50 m metallic flexible hose and Stella 100/3F Handshower.

**A5A9A6E..0**

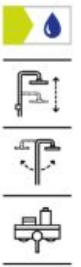
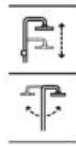

### Vega

Single-lever shower column adjustable in height. Shower head ø 200 mm, 1.50 m metallic flexible hose and Stella 100/3F Handshower.

**A5A976E..0**

### Vega Plus Square

Single-lever shower column adjustable in height. Shower-head 250 x 250 mm, 1.50 m metallic flexible hose and Stella 100/3F handshower.

**A5A9C6E..0**

### Deck-C

Columna de ducha con inversor y repisa, conectable a cualquier grifería. Incluye Rotating shower de ø 230 mm, ducha de mano de ø 110 mm de 3 funciones, flexible de PVC de 1,5 m y soporte articulado regulable en altura.

**A5A9M09..0**

## Floorstanding Columns

---



Floorstanding column with  
Handshower bracket.

**A525866800**



Floorstanding columns.

**A525897500**

## Built-in Packs



Thermostat RocaBox Square

Pack with built-in thermostatic mixer T-2000 2-ways with RocaBox, ABS RainSense 360 x 240 mm shower head, L400 mm wall arm Square, Aqua Square water inlet, 1.70 m metal shower hose Neoflex and Stella Stick Square handshower.

**A5D1088C00**



Thermostat RocaBox Round

Pack with built-in thermostatic mixer T-1000 2-ways with RocaBox, ABS RainSense Ø250 mm shower head, L400 mm wall arm, Aqua Round water inlet, 1.70 m metal shower hose Neoflex and Stella Stick Round handshower.

**A5D1A09C00**



Basic Thermostat T-500

Pack with built-in thermostatic mixer T-500 2-ways, RainSense Ø200 mm shower head, L400 mm wall arm, Aqua Round water inlet, 1.70 m metal shower hose Neoflex and Stella 100/3 handshower.

**A5D0718C00**



Single-lever RocaBox Atlas

Pack with built-in single-lever mixer Atlas Square 2-ways with RocaBox, ABS RainSense 360 x 240 mm shower head, L400 mm square wall arm, Aqua Square water inlet, 1.70 m metal shower hose Neoflex and Stella Stick Square handshower.

**A5D2690C00**



Single-lever RocaBox Cala

Pack with built-in mixer Cala 2-ways with RocaBox, RainSense Ø250 mm shower head, L400 mm wall arm, Aqua Round water inlet, 1.70 m metal shower hose Neoflex and Stella Stick Round handshower.

**A5D266EC00**



Single-lever Cala Matt Black

Pack with built-in matt black mixer Cala 2-ways with RocaBox, RainSense Ø250 mm matt black shower head, L400 mm matt black wall arm, Aqua Round matt black water inlet, 1.70 m matt black metal shower hose Neoflex and Stella 100/3 matt black handshower.

**A5D186ENB0**

## Built-in Packs



### Basic single-lever Monodin

Pack with built-in mixer Monodin 2-ways with RainSense Ø 200 mm shower head, L400 mm wall arm, Aqua Round water inlet, 1.70 m metal shower hose Neoflex and Stella 100/3 handshower.

**A5D0518C00**



### Basic single-lever L20

Pack with built-in mixer L20 2-ways, RainSense Ø200 mm shower head, L400 mm wall arm, Aqua Round water inlet, 1.70 m metal shower hose Neoflex and Stella 100/3 handshower.

**A5D1809C00**



### Single-lever L20 in Matt Black

Pack with L20 built-in bath-shower mixer, shower-head ø250 mm and shower set with 100 mm, 3 functions Stella handshower, adjustable Hand-shower bracket and 1.70 m flexible hose

**A5D2209C00**



### Single-lever Victoria Plus

Pack. Includes: Victoria Plus built-in bath-shower mixer, shower-head ø250 mm and shower set with 100 mm, 3 functions Stella handshower, adjustable Hand-shower bracket and 1.70 m flexible hose.

**A5D184FC00**

# Handshowers







**Available in sleek round and square designs, hand showers offer stylish ways to enhance the shower experience. With one to four functions, they allow easy adjustment of the water flow through a simple integrated function selector. Easy to clean and available in a range of contemporary colours, these handshowers add both versatility and appeal to any bathroom.**

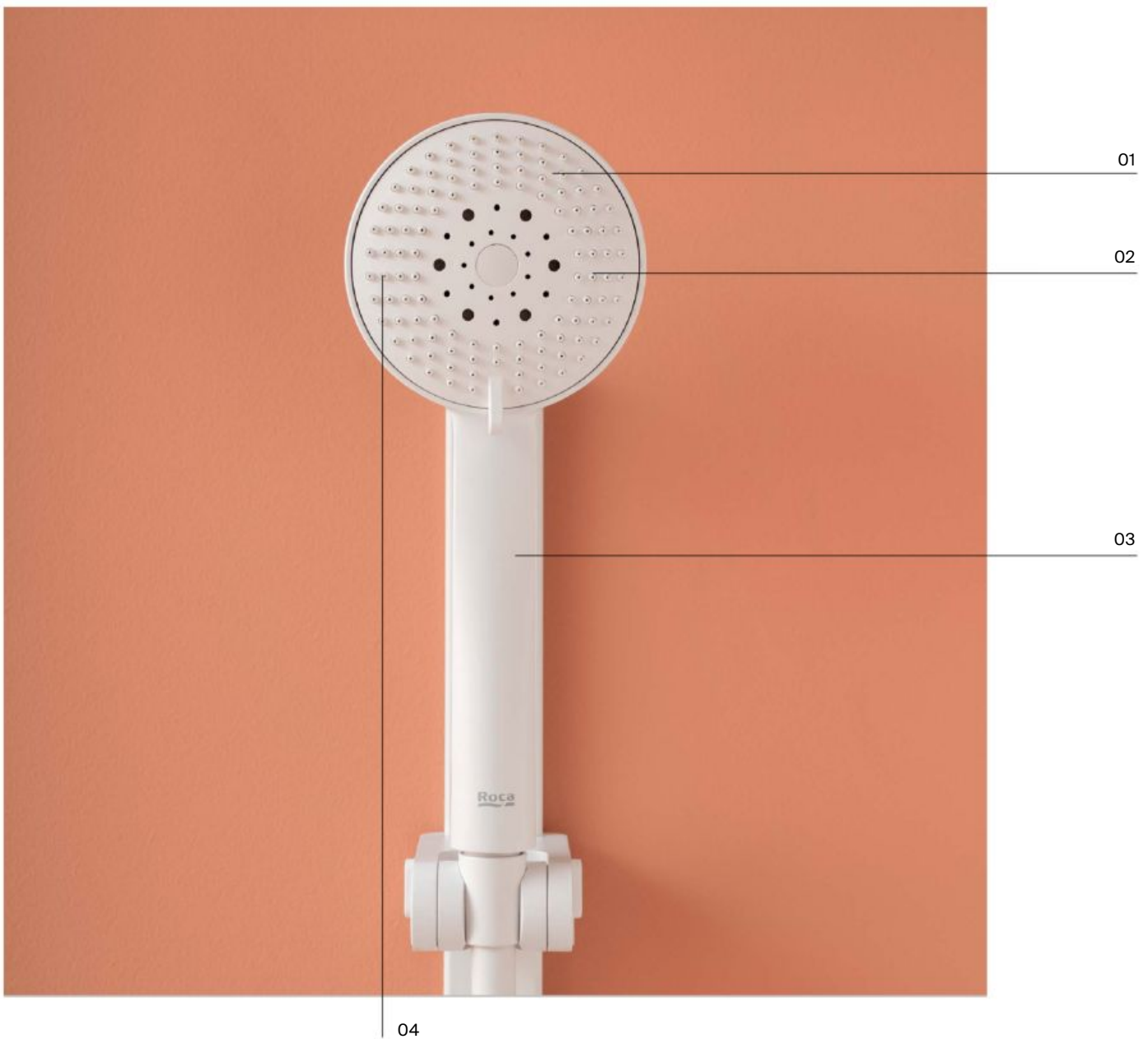

- 01 Easy Clean.
- 02 Silicone faceplate for a better and cleaner environment
- 03 Complete and coherent range:  
100, 110, 130 / 1F, 3F / Finishes
- 04 Great performance even with low flow rates

Handshower collections feature new and improved designs with silicone nozzles and faceplates for easy cleaning. The Stella collection is inspired by basic elements of nature, Sensum includes advanced features to help save water and Plenum has a new integrated button to easily switch between the handshower's three functions.

**Benefits**

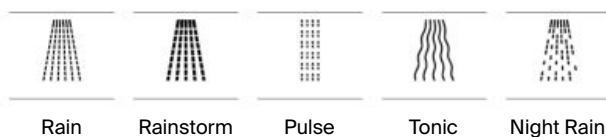

































**Finishes**

- C0 Chrome
- CN Titanium Black
- RG Rose Gold
- NM Brushed Black
- NB Matt Black
- BO Matt White
- VA Brushed Brass



Replace (..) in the product reference with the code of the chosen finish.

# Handshowers

  	  	  
<p>Plenum 130/3 Handshower with 3 functions. <b>A5B8114..0</b></p> 	<p>Sensum 110/1 Handshower with 1 function. <b>A5BCB09..0</b></p> 	<p>Sensum 110/3 Handshower with 3 functions. <b>A5BG109..0</b></p> 
  	  	  
<p>Stella 100/3 Handshower with 3 functions. <b>A5B8113..0</b></p> 	<p>Stella 100/1 Handshower with 1 function. <b>A5B3113C00</b> 8L/min. <b>A5BCB13C00</b> 6L/min.</p> 	<p>Stella 80/3 Handshower with 3 functions. <b>A5B1103C00</b></p> 
 	 	 
<p>Stella 80/1 Handshower with 1 function. <b>A5B9103C00</b></p> 	<p>Stella Stick Round 25/1 Handshower with 1 function. <b>A5B9B61..0</b></p> 	<p>Stella Stick Square 22/1 Handshower with 1 function. <b>A5B9L61C00</b></p> 

## Handshowers

---



Loft 18/1  
Handshower with 1 function.  
**A505319400**



Carmen 83/1  
Handshower with 1 function.  
● **A5B114BC00**



Natura 80/1  
Handshower with 1 function.  
● **AG0082700R**

# Shower Kits



Plenum 130/3

Shower kit. 3 functions, 130 mm handshower, 700 mm slide bar with adjustable Hand-shower bracket and 1.70 m PVC shower flexible hose.

**A5B8414C00**

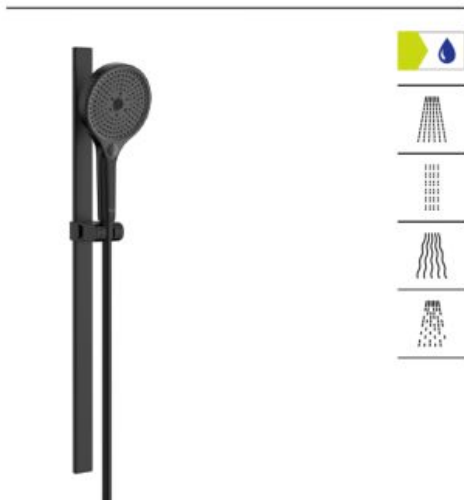

Plenum 130/3

Shower kit. 3 functions, 130 mm handshower, 700 mm slide bar with adjustable Hand-shower bracket and 1.70 m PVC shower flexible hose.

**A5B8E14..0**



Sensum 130/3

Shower kit. 3 functions, 110 mm handshower, 700 mm slide bar with adjustable Hand-shower bracket and 1.70 m PVC shower flexible hose.

**A5BG409C00**

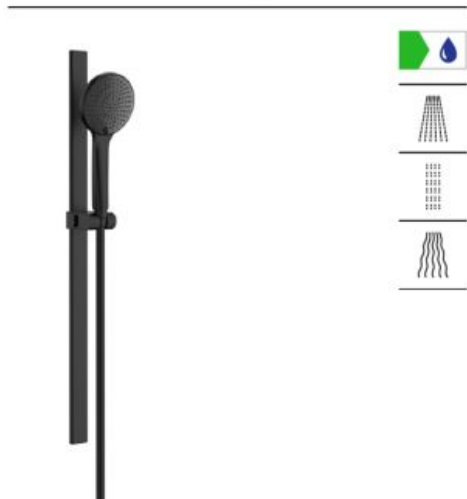

Sensum 130/3

Shower kit. 3 functions, 110 mm handshower, 700 mm slide bar with adjustable Hand-shower bracket and 1.70 m PVC shower flexible hose.

**A5BGE09..0**



Stella 100/3

Shower kit. 3 functions, 100 mm handshower, 700 mm slide bar with adjustable Hand-shower bracket and 1.70 m PVC shower flexible hose.

**A5B8413C00**



Stella 100/3

Shower kit. 3 functions, 100 mm handshower, 700 mm slide bar with adjustable Hand-shower bracket and 1.70 m PVC shower flexible hose.

**A5B8E13..0**

## Shower Kits

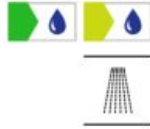

Stella 100/1

Shower kit. 1 function, 100 mm handshower, 700 mm slide bar with adjustable Hand-shower bracket and 1.70 m PVC shower flexible hose.

**A5B3413C00** 8L/min.

**A5BC413C00** 6L/min.



Stella 80/3

Shower kit. 3 functions, 80 mm Handshower, 700 mm slide bar with adjustable Handshower bracket and 1.70 m PVC shower flexible hose.

● **A5B1403C00**



Stella 80/1

Shower kit. 1 function, 80 mm Handshower, 700 mm slide bar with adjustable Handshower bracket and 1.70 m PVC shower flexible hose.

● **A5B9403C00** ●

# Shower Sets

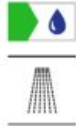

Sensum 110/1

Shower set. 1 function, 110 mm handshower, adjustable Hand-shower bracket and 1.70 m PVC shower flexible hose.

**A5BCD09C00**

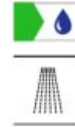

Sensum 110/3

Shower set. 3 functions, 110 mm handshower, adjustable Hand-shower bracket and 1.70 m PVC shower flexible hose.

**A5BG309..0**

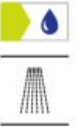

Stella 100/3

Shower set. 3 functions, 100 mm handshower, adjustable Hand-shower bracket and 1.70 m PVC shower flexible hose..

**A5B8313..0**

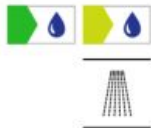

Stella 100/1

Shower set. 1 function, 100 mm handshower, adjustable Hand-shower bracket and 1.70 m PVC shower flexible hose.

**A5B3313C00** 8L/min.

**A5B3D13C00** 6L/min.



# Shower Heads





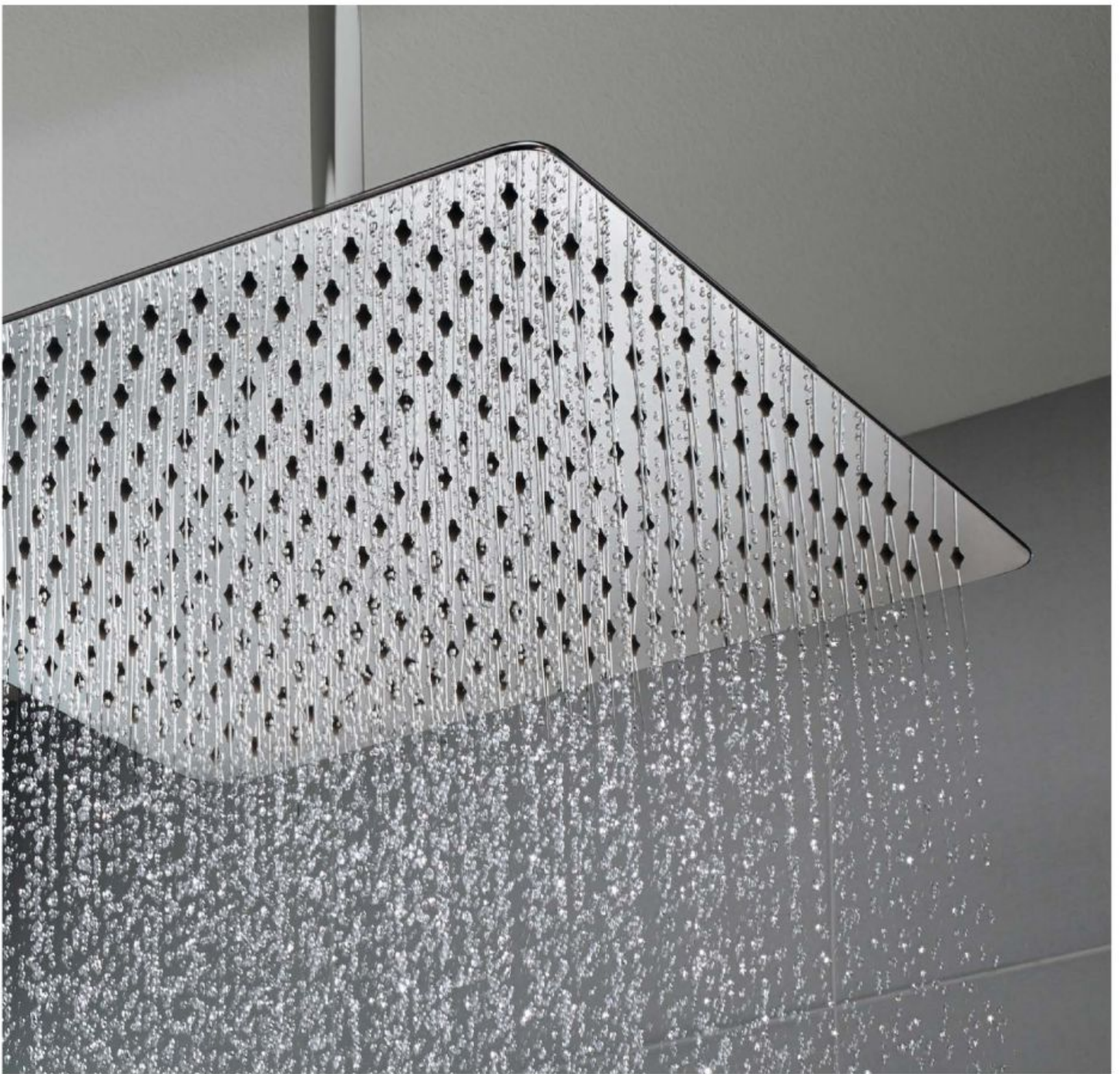

**Available in both wall-mounted and ceiling-mounted options, showerheads combine elegance with functionality and come in a variety of sizes to suit any space. With multiple jet settings ranging from a gentle rain to a soothing waterfall, they create a truly customisable shower environment. Available in five stunning finishes, these showerheads add a touch of luxury and style to any bathroom.**



01

03

02

- 01 Available in 5 finishes.
- 02 Multiple jets for a more pleasant feeling
- 03 Waterfall function

Roca's shower heads offer a range of experiences, from a gentle rain sensation to a soothing waterfall.

### Benefits

STAINLESS STEEL	METAL	ABS		
Rain	Rainstorm	Pulse	Tonic	Night Rain

### Finishes

- CO Chrome
- CN Titanium Black
- RG Rose Gold
- NM Brushed Black
- NB Matt Black
- BO Matt White
- VA Brushed Brass
- SM Stainless Steel Finish



Replace (..) in the product reference with the code of the chosen finish.

# Shower Heads



STAINLESS  
STEEL

Raindream  
ø 380 mm

Extra slim metallic shower head for ceiling installation. Rain function.

**A5B3150C00**



STAINLESS  
STEEL

Raindream  
350 x 350 mm

Extra slim metallic shower head for ceiling installation. Rain function.

**A5B3250C00**



Raindream  
500 x 500 mm

Stainless steel shower head for ceiling installation. Rain and Waterfall functions.

**A5B124A..0**



Raindream  
380 x 380 mm

Stainless steel shower head for ceiling installation. Rain and NightRain functions.

**A5B114A..0**



Raindream  
380 x 380 mm

Stainless steel shower head for ceiling installation. Rain function.

**A5B104A..0**



Raindream  
270 x 587 mm

Stainless steel shower head for wall installation. Rain and Waterfall functions.

**A5B134A..0**



Raindream  
165 x 537 mm

Stainless steel shower head for wall installation. Rain and Waterfall functions.

**A5B144A..0**



Raindream  
165 x 537 mm

Stainless steel shower head for wall installation. Rain function.

**A5B184A..0**

# Shower Heads



STAINLESS  
STEEL

Raindream

500 x 500 mm

Stainless steel shower head for ceiling or wall installation. Rain function. Support kit / arm not included.

**A5B3550C00**



STAINLESS  
STEEL

Raindream

400 x 400 mm

Stainless steel shower head for ceiling or wall installation. Rain function. Support kit / arm not included.

**A5B2850C00**



STAINLESS  
STEEL

Raindream

ø 400 mm

Stainless steel shower head for ceiling or wall installation. Rain function. Support kit / arm not included.

**A5B2650C00**



STAINLESS  
STEEL

Raindream

300 x 300 mm

Stainless steel shower head for ceiling or wall installation. Rain function. Support kit / arm not included.

**A5B2750C00**



STAINLESS  
STEEL

Raindream

ø 300 mm

Stainless steel shower head for ceiling or wall installation. Rain function. Support kit / arm not included.

**A5B2550C00**



STAINLESS  
STEEL

Raindream

250 x 250 mm

Stainless steel shower head for ceiling or wall installation. Rain function. Support kit / arm not included.

**A5B2450C00**



STAINLESS  
STEEL

Raindream

200 x 200 mm

Stainless steel shower head for ceiling or wall installation. Rain function. Support kit / arm not included.

**A5B2B50C00**



STAINLESS  
STEEL

Raindream

ø 200 mm

Stainless steel shower head for ceiling or wall installation. Rain function. Support kit / arm not included.

**A5B2A50C00**



METAL

Raindream

300 x 300 mm

Brass shower head for ceiling or wall installation. Rain function. Everlux finishes. Support kit / arm not included.

**A5B4050..0**



METAL

Raindream

ø 300 mm

Brass shower head for ceiling or wall installation. Rain function. Everlux finishes. Support kit / arm not included.

**A5B3950..0**



ABS

Rainsense

360 x 240 mm

ABS shower head for ceiling or wall installation. Support kit / arm not included.

**A5B3050C00**



ABS

Rainsense

ø 250 mm

ABS shower head for ceiling or wall installation. Support kit / arm not included.

**A5B2250..0**

# Shower Heads



ABS

Rainsense  
200 x 200 mm

ABS shower head for ceiling or wall installation. Support kit / arm not included.

**A5B2350C00**



METAL

Rainsense  
ø 200 mm

Metallic shower head for ceiling or wall installation. Support kit / arm not included.

**A5B2950C00**



ABS

Rainsense  
ø 200 mm

ABS shower head for ceiling or wall installation. Support kit / arm not included.

**A5B2150C00**



ABS

Rainsense  
ø 230 mm

ABS shower head with silicone front plate for ceiling or wall installation. Support kit/arm not included

**A5B1803.0**



ABS

Rainsense  
ø 200 mm

Classic ABS shower head for ceiling or wall installation. Support kit / arm not included.

**A5B3350C00**



Stella  
ø 100 mm

Adjustable shower head for wall installation with 3 functions: Rain, Soft, and Pulse. Support kit / arm not included.

**A5BF103C00**



Stella  
ø 100 mm

Adjustable shower head for wall installation with 1 function: Rain. Support kit / arm not included.

**A5BH103C00**

# Complements





**A wide array of showering components is available to cater to every aspect of your installation requirements. All components are compatible and tailored to suit various styles and preferences, making it easier to design and install a customised shower setup.**

# Shower Heads



Ceiling arm for shower head.

**A5B0650C00** 300 mm

**A5B0550..0** 200 mm

**A5B0450C00** 100 mm



Ceiling arm for shower head.

**A5B0650C00** 300 mm

**A5B0550..0** 200 mm

**A5B0450C00** 100 mm



Wall arm for shower head. Compatible with RainDream and RainSense.

**A5B0350C00** 500 mm

**A5B0250..0** 400 mm

**A5B0150C00** 300 mm

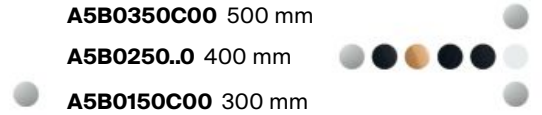

215 mm

Wall arm for shower head. Compatible with Stella.

**A5B0750C00**



400 mm

Square straight wall arm for shower head.

**A5B0950C00**



Fit

Vandal-proof shower head.

**A5B6661C00**



Puzzle

42 x 42 mm

Jet orientable Square.

**A5B154A..0**



Puzzle

ø 50 mm

Jet orientable Round.

**A5B174A..0**



Concealed swivel jet with 1 function for shower spaces.

**A5B3778C00**



Round swivel jet

Concealed swivel jet with 1 function for shower spaces.

**A5B3878C00**



# Bars



Stella  
700 mm  
Height-adjustable shower slide bar with adjustable Hand-shower bracket.

**A5B0713C00**



Deck  
700 mm  
Shower bar with sliding Hand-shower bracket and height-adjustable shelf.

**A5B07S2..0**



Clasica  
700 mm  
Shower slide bar with adjustable Handshower bracket.

**A5B3450C00**



Sensum  
700 mm  
Height-adjustable shower slide bar with adjustable Hand-shower bracket.

**A5B0709..0**



Minimal  
700 mm  
Height-adjustable shower slide bar with adjustable Hand-shower bracket.

**A5B07S1..0**



Soap dish for shower bar.

**A5B5150C00**  
Soap dish for shower bar. Transparent.

**A5B5150TP0**

# Flexible Shower Hose

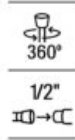

Satin PVC flexible shower hose

1/2" Anti-torsion shower hose in satin PVC.

**A5B2016C00** 2 m

**A5B2116..0** 1.75 m

**A5B2216C00** 1.50 m

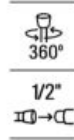

PVC flexible shower hose

1/2" Anti-torsion shower hose in PVC.

**A5B2316C00** 2 m

**A5B2416C00** 1.70 m

**A5B2516C00** 1.50 m



Metallic flexible shower hose

1/2" Anti-torsion metallic shower hose.

**A5B2616C00** 2 m

**A5B3850..0** 1.70 m

**A5B2816C00** 1.50 m

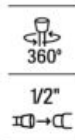

Flexo Neo-Flex PVC

1,7 m

Flexible PVC anti-torsión 1/2" universal.

**A5B2117..0**



Flexo Neo-Flex PVC

1,5 m

Flexible PVC anti-torsión 1/2" universal.

**A5B2118..0**



## Water Inlets and Brackets



Aqua Classic

Water inlet for shower hose chrome 1/2".

**AG0083700R**



Aqua Round

Water inlet for shower hose chrome 1/2".

**A5B1450..0**



Aqua Square

Water inlet for shower hose chrome 1/2".

**A5B1150C00**



Aqua Round with bracket

1/2" water inlet for shower hose with integrated bracket for hand shower.

**A5B5250..0**



Aqua Square with bracket

1/2" water inlet for shower hose with integrated bracket for hand shower.

**A5B0850C00**



Wall Square

Swivel bracket for hand shower.

**A525021600**



Wall Round

Swivel bracket for hand shower.

**AG0068500R**



Wall Classic

Swivel bracket for hand shower.

**AG0067000R**



Wall

Swivel bracket for hand shower.

**A5B5350C00**



Bracket

Wall swivel bracket. Fixed swivel bracket.

**AG0237600R**



Wall

Fixed chromed bracket for hand shower.

**A526704010**



Square

Fixed chromed bracket for hand shower.

**A5B1250C00**



Round

Fixed chromed bracket for hand shower.

**A5B1350..0**



## Bidet Shower Kits



Be Fresh

Shower kit mixer (1 way) with Handshower, integrated bracket - water inlet with auto-stop and metal flexible hose.

**A5B9461C00**



Be Fresh

Shower kit progressive mixer (1 way) with Handshower, integrated bracket - water inlet with auto-stop and metal flexible hose.

**A5B9361C00**



Be Fresh

Bidet shower kit (1 way) with Handshower, integrated bracket - water inlet with auto-stop and 1.2 m metal flexible hose.

**A5B9161C00**



Be Fresh

Bidet shower kit (2 ways) with Handshower, integrated bracket - water inlet with auto-stop and 1.2 m metal flexible hose.

**A5B9261C00**



Be Fresh Go

Bidet shower kit (1 way) with Handshower, integrated bracket - water inlet and 1.2 m metal flexible hose.

**A5B9130..0**



Square

Fixed chromed bracket for hand shower.

**A5B1250C00**



Be Fresh One

Bidet shower kit (1 way) with Handshower, integrated bracket - water inlet and 1.2 m metal flexible hose.

**A5B9330C00**



Be Fresh One

Shower kit progressive mixer (1 way) with Handshower, integrated bracket - water inlet with auto-stop and 1.2 m metal flexible hose.

**A5B9D30C00**



Be Fresh One

Bidet shower kit (1 way) with Handshower, integrated bracket - water inlet, angle valve and 1.2 m metal flexible hose.

**A5B9M30C00**



Be Fresh One

Bidet shower kit (1 way) with Handshower, integrated bracket - water inlet and 1.2 m metal flexible hose.

**A5B9330C00**

# Valves



Stop valve (ceramic valve).  
**A525164400** 1/2" - 3/8"



Stop valve (ceramic valve).  
**A525164500** 1/2" - 1/2"



Stop valve (ceramic valve).  
**A5251679..** 1/2" - 3/8"  
**A5251707..** 1/2" - 1/2"



Eco Filter angle valve  
Stop valve (ceramic valve).  
**A525168200** 1/2" - 3/8"  
**A525171000** 1/2" - 1/2"



Filter angle valve  
Stop valve (ceramic valve).  
**A525168300** 1/2" - 3/8"  
**A525171100** 1/2" - 1/2"



Regulating valve (chrome plated  
ABS valve).  
**A525165800** 1/2" - 3/8"  
**A525165900** 1/2" - 1/2"



Regulating valve (metallic chrome valve).  
**A525166000** 1/2" - 3/8"  
**A525166100** 1/2" - 1/2"



Cross built-in valve  
Built-in valve.  
**A525168400** 1/2" - 1/2"



Round built-in valve  
Built-in valve.  
**A525168500** 1/2" - 1/2"

## Universal Flow Limiters

---



4L

Universal flow limiter shower 1/2". 6 l/m.

**AG0099307R**

Universal flow limiter shower 1/2". 4 l/m.

**AG0099407R**

## Wastes for Basins



Click-clack universal waste.  
Vitreous plug

Ø 65.

**A505401100**



Click-Clack Universal waste

Ø 65 mm

**A505401000** Chrome cover

**A5054015..**



Click-Clack Universal waste  
Chromed plug

Ø 40.

**A505400900**



Always open Universal Waste  
Waste for basin or bidet with fixed  
chrome-plated cover. Chrome.

**A506403900**



Ceramic always open Universal waste  
Waste for toilet or bidet with ceramic fix  
cover Ø 72.

**A50640390C** White ceramic cover

**A5064039..** Matt colours cover



Dual universal waste  
Dual universal drain.

**A5054033C0**



Roca



# Kitchen Area

Roca's kitchen faucets offer various styles, shapes, and colours that enhance kitchen design and performance with energy-saving features. Ergonomic designs, versatile functions, and electrolytic coatings reflect Roca's high standards. Innovative features include Cold Start and ceramic cartridges, with soft movement, steady flow aerators, and low noise applications for everyday satisfaction.



**Subtle yet essential features provide pleasant everyday experiences and long-term satisfaction**

## Key Benefits

---

**Wide range.** Variety of styles and configurations for all kitchen needs and styles.

**Pull-out spout.** Pull-out sprayer with two functions: laminar splash-free function and spray function.

**Shower function.** Models with shower function for a more effective and efficient rinse.

**Cold start.** Cold opening that guarantees energy savings up to 35%\*.

**Durability.** All models feature Roca's exclusive ceramic cartridge, which allows a soft and precise operation, with the guarantee of one million opening and closing movements.

**Evershine.** Electrolytic coating guarantees permanent shine over time and makes cleaning easier.

**Everlux.** Physical vapor deposition (PVD) process, ensuring a perfectly even finish.

**Matt finishes.** Polyester thermosetting powder coating based on polyester resins.

\*Based on annual savings for a family of 4, considering 2 minutes per day of toothbrushing and handwashing 5 times a day.



**Benefits**

Cold Start	Pull-out spout	Pull-out spout	Flow control	Spout that folds back
Touchless	7L/min	8L/min	9L/min	10L/min
11L/min	12L/min			

**Finishes**

- C0 Chrome
- NB Matt Black

Unified Water Label	6 l/min
Unified Water Label	6,5 l/min
Unified Water Label	7 l/min

Replace (..) in the product reference with the code of the chosen finish.

# Kitchen Faucets



Syra-E

Electronic kitchen mixer with retractable 2-function shower and flexible supply hoses. Cold Start. Mains operated at 230V. Includes power source.

**A5A8A2AC00**



Syra

Kitchen mixer with retractable swivel spout, rinse spray function and flexible supply hoses. Cold Start.

**A5A812AC00**

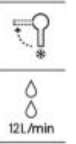

Syra

Kitchen sink mixer with swivel spout and flexible supply hoses. Cold Start.

**A5A842AC00**

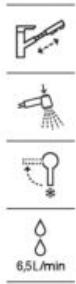

Syra

Kitchen sink mixer with retractable swivel spout, rinse spray function and flexible supply hoses. Cold Start.

**A5A852AC00**

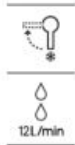

Syra

Kitchen sink mixer with swivel spout and flexible supply hoses. Cold Start.

**A5A832AC00**



Carmen

Kitchen mixer with swivel spout, and flexible supply hoses. Cold Start. Twin-lever.

**A5A844BC00**

# Kitchen Faucets

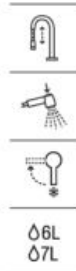

Glera Pro

Kitchen mixer with retractable, professional and metallic swivel spout, 2-function rinse spray and flexible supply hoses. Cold Start.

**A5A8A4DC00**



Glera Pro

Kitchen mixer with retractable, professional and metallic swivel spout, 2-function rinse spray and flexible supply hoses. Cold Start.

**A5A8A4DC00**



Glera

Kitchen mixer with retractable swivel spout, 2-function rinse spray and flexible supply hoses. Cold Start.

**A5A814DC00**



Glera

Kitchen mixer with retractable swivel spout and flexible supply hoses. Cold Start.

**A5A844DC00**



Glera

Kitchen mixer with retractable swivel spout, 2-function rinse spray and flexible supply hoses. Cold Start.

**A5A854DC00**

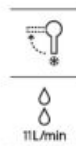

Glera

Kitchen mixer with retractable swivel spout and flexible supply hoses. Cold Start.

**A5A834DC00**

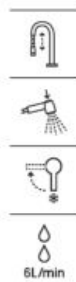

Ona

Kitchen mixer with swivel and retractable 2-function pull-down spout and flexible supply hoses. Cold Start.

**A5A811F.0**



Ona

Kitchen mixer with swivel spout and flexible supply hoses. Cold Start.

**A5A841F.0**

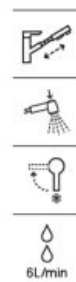

Ona

Kitchen mixer with swivel and retractable 2-function pull-out spout and flexible supply hoses. Cold Start.

**A5A851F.0**

# Kitchen Faucets

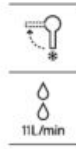

Ona  
Kitchen mixer with swivel spout and flexible supply hoses. Cold Start.

**A5A831F..0**

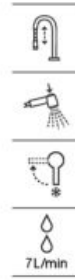

Cala  
Kitchen mixer with retractable swivel spout, 2-function rinse spray and flexible supply hoses. Cold Start.

**A5A816E..0**

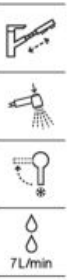

Cala  
Kitchen mixer with retractable swivel spout, 2-function rinse spray and flexible supply hoses. Cold Start.

**A5A856E..0**

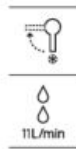

Cala  
Kitchen mixer with swivel spout and flexible supply hoses. Cold Start.

**A5A846E..0**

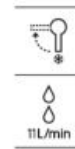

Cala  
Kitchen mixer with swivel spout and flexible supply hoses. Cold Start.

**A5A836E..0**

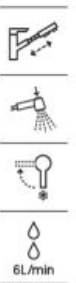

Cala  
Kitchen mixer with retractable swivel spout, 2-function rinse spray and flexible supply hoses. Cold Start.

**A5A806E..0**



Mencia  
Kitchen mixer with swivel spout and flexible supply hoses. Cold Start.

**A5A7409..0**



L20  
Kitchen mixer with folding swivel spout, and flexible supply hoses. Cold Start.

**A5A8209C00**

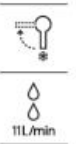

L20  
Kitchen mixer with swivel spout, and flexible supply hoses. Cold Start.

**A5A8409C00**

## Kitchen Faucets

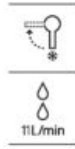

L20  
Kitchen mixer with swivel spout and flexible supply hoses. Cold Start.

**A5A8909C00**



L20  
Wall-mounted Kitchen mixer with swivel spout.

**A5A7609C00**



Victoria Plus  
Single-lever kitchen sink mixer. With swivel spout and flexible supply hoses.

**A5A8E4FC00**



Victoria Plus  
Mezclador monomando exterior para cocina con caño alto giratorio y enlaces de alimentación flexibles.

**A5A844FC00**



Victoria Plus  
Single-lever kitchen sink mixer. With swivel spout and flexible supply hoses.

**A5A894FC00**



Victoria Plus  
Single-lever kitchen sink mixer. With swivel spout and flexible supply hoses.

**A5A864FC00**



Victoria Plus  
Kitchen mixer with swivel spout and aerator.

**A5A764FC00**



Victoria Plus  
Kitchen mixer. With lateral handle, swivel spout and flexible supply hoses.

**A5A844FC00**



Brava  
Twin-lever kitchen mixer with swivel spout and flexible supply hoses.

**A5A848EC00**



## Kitchen Faucets



Brava

Kitchen faucet with swivel spout and flexible supply hoses.

**A5A868EC00**



Brava

Wall-mounted twin-lever kitchen mixer with swivel spout and flexible supply hoses.

**A5A748EC00**



Brava

Wall-mounted single-lever kitchen faucet with swivel spout and flexible supply hoses.

**A5A858EC00**



Brava

Wall-mounted twin-lever kitchen mixer with swivel spout and flexible supply hoses.

**A5A768EC00**



Brava

Wall-mounted single-lever kitchen faucet with lower swivel spout.

**A5A878EC00**

# Roca Aquafy

## Filtered Water Faucets





**Aquafy, Roca's kitchen filtration system, offers a safe, convenient, and sustainable solution for cooking and drinking. With easy installation under the sink, the collection includes a variety of faucets with three designs and two finishes, each equipped with a five-stage filter integrated into the faucet. An LED light provides a timely alert when the filter requires replacement, ensuring continuous access to clean and filtered water.**



**Eliminate plastic bottles and reduce carbon footprint**

## Key Benefits



1,200 litres



5,581 glasses

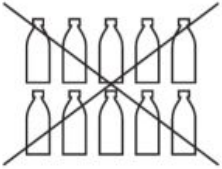

800  
plastic bottles

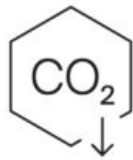

199,250 g  
Equivalent to over  
1600 km in car travel

**Healthy.** Good quality drinking water with no chlorine taste or smell.

**Ecological.** Sustainable solution to plastic bottles.

**Instantly.** Healthy water straight from the tap by simply turning the left handle.

**Economical.** Filtration capacity of 1,200 litres of water per cartridge.

**Easy to maintain.** Replaceable filter cartridge in less than 10 seconds.

**Ideal for cooking.** Cleaner water without substances such as chlorine that alter the taste of food.

## 5 Stage Filter System

5.  
Fine Filtration

3.  
Membrane  
Filtration

1.  
High-Performance  
Ion Exchange Unit



4.  
Activated Carbon  
Block Filtration

2.  
Sediment  
Filtration

### 1. High-Performance Ionic Exchanger

Removes limescale and other substances to soften water.

### 2. Sediment Filtration

Captures solid impurities like small solid particles, sediment and rust.

### 3. Membrane Filtration

Eliminates particles, bacteria, viruses, and heavy metals.

### 4. Activated Carbon Block Filtration







Removes all impurities, including colour, odour, and residual chlorine.

### 5. Fine Filtration

Eliminates even the tiniest particles, including any remaining carbon granules.



**Benefits**

		
Dual Spout	Pull-out spout	Filtered water
		
Cold Start	Soft Turn	LED Signal

**Finishes**

- C0 Chrome
- NB Matt Black
- SM Stainless Steel Finish

Replace (..) in the product reference with the code of the chosen finish.

## Filtered Water Faucets

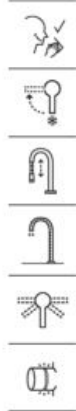

Roca Aquafy

Kitchen mixer with 2 ways for filtered water and tap water, retractable swivel C-Spout, rinse spray function, and flexible supply hoses. Cold Start. 5-stage filter included.

**A5A8D3G..0**



Roca Aquafy

Kitchen mixer with 2 ways for filtered water and tap water, swivel C-Spout, and flexible supply hoses. Cold Start. 5-stage filter included.

**A5A8C3G..0**



Roca Aquafy

Kitchen mixer with 2 ways for filtered water and tap water, swivel U-Spout, and flexible supply hoses. Cold Start. 5-stage filter included.

**A5A8B3G..0**



Roca Aquafy

Kitchen faucet for filtered water and flexible supply hoses C-Spout. 5-stage filter included.

**A5A8A3GC00**



5-stage filter for kitchen mixer with filtered water. Capacity of 1,200 litres. Durability of 6 - 12 months.

**A5A803GB00**





# Public Spaces

**Roca's electronic faucets feature a next generation 'Intelligent System' with touchless operation. A motion sensor activates the faucet instantly, ensuring that water is only used when it is needed, preventing waste. This technology ensures reliability, durability and significant water and energy savings. Ideal for public and semi-public spaces, these faucets maximise efficiency and conservation.**

# Electronic Basin Mixers





**A focus on hygiene and prevention is driving innovative technological solutions in public bathrooms. Advanced presence sensors and electronic mechanisms define a new generation of basin mixers and WC and urinal flush plates, These touch-free systems help reduce the spread of viruses, making them ideal for high-traffic areas where cleanliness is essential.**



**Precise control  
of water, at your  
fingertips**

## Key Benefits

---

The robust design has been developed for high-traffic public areas and ensures exceptional durability. With concealed aerators, both products are protected against vandalism, ensuring long-lasting performance in demanding environments.

**Easy installation.** The installation is the same as that of the usual single lever faucet.

**Reliability.** Design and manufacturing process certified to ISO 9001:2008 and ISO 14001:2004 standards. The electronic faucet meets the requirements of the European standard EN-15091:2006.

### Electronic faucets

**Hygiene.** Designed with pure, modern lines and contact-free operation, guaranteeing maximum hygiene.

**Water and energy saving.** Infrared presence activation, providing waste-free water, and automatic shut-off after 60 seconds of continuous use.

**Mains or battery powered.** The electronic series are suitable for public spaces with mains or battery powered options. Battery models include a low power indicator light.

### Timed faucets

**Water saving.** Instant and Avant faucets with limited flow to preserve the environment. In Avant, the water output time is predefined for efficient use.

**Versatility of use.** Versatile series suitable for various spaces such as hotels, offices, hospitals, schools, gyms, campsites, nursing homes, shopping centres, bars and restaurants.



01

02







03

05

04

- 01 Resistant materials. Evershine
- 02 Slender design with electro-valve included in the body
- 03 Comfort for the user. Temperature control.
- 04 Security. Infra-red sensor with automatic shut-off valve
- 05 Sustainable. 5l/min flow limiter.

#### Benefits

		ONE WATER	PRE-MIXED WATER	ECO
Touchless				
				
2L/min	3L/min	5L/min	5,7L/min	6L/min

#### Finishes

- CO Chrome

Unified Water Label		5 l/min
Unified Water Label		5,7 l/min
Unified Water Label		6 l/min

Replace (..) in the product reference with the code of the chosen finish.

# Electronic Faucets



Ona-E

Electronic basin faucet (one water). With flexible supply hoses. M-Size. Powered by 4 1,5 V LR6 (AA) batteries. Batteries not included.

**A5A569EC00**

Electronic basin faucet (one water). With flexible supply hoses. M-Size. Mains operated at 230V. Power source included.

**A5A579EC00**

Optional:

Touchless soap or hand sanitizer dispenser, deck-mounted (AC). Mains operated at 100- 240V. Includes power source.

**A818014C00**

Touchless soap or hand sanitizer dispenser, deck-mounted (DC). Powered by 4 alkaline batteries 1.5V D/LR20 (not included).

**A818020C00**



Ona-E

Touchless soap or hand sanitizer dispenser, deck-mounted (DC). Powered by 4 alkaline batteries 1.5V D/LR20 (not included).

**A818020C00**

Touchless soap or hand sanitizer dispenser, deck-mounted (AC). Mains operated at 100-240V. Includes power source.

**A818014C00**



Ona-E

Electronic basin mixer (DC) with flexible supply hoses. M-Size. Powered by 4 alkaline batteries 1.5V D/LR20 (not included).

**A5A539EC00**

Electronic basin mixer (AC) with flexible supply hoses. M-Size. Mains operated at 230V. Includes power source.

**A5A559EC00**

Optional:

Touchless soap or hand sanitizer dispenser, deck-mounted (DC). Powered by 4 alkaline batteries 1.5V D/LR20 (not included).

**A818020C00**

Touchless soap or hand sanitizer dispenser, deck-mounted (AC). Mains operated at 100-240V. Includes power source.

**A818014C00**



Cala-E

Electronic basin faucet (one water). With flexible supply hoses. Powered by 4 1,5 V LR6 (AA) batteries. Batteries not included. M-Size.

**A5A566EC00**

Electronic basin faucet (one water). With flexible supply hoses. Mains operated at 230V. Power source included. M-Size

**A5A576EC00**



Cala-E

Electronic basin mixer. With flexible supply hoses. S-Size. Powered by 4 alkaline batteries 1.5V D/LR20 (not included).

**A5A536EC00**

Electronic basin mixer. With flexible supply hoses. S-Size. Mains operated at 230V. Includes power source.

**A5A556EC00**



L30-E

Electronic basin mixer with flexible supply hoses. S-Size. Powered by 4 alkaline batteries 1.5V LR6 (AA) (not included) or mains operated at 230V.

**A5A5809C00**

# Electronic Faucets



L20-E

Electronic basin faucet (one water). S-Size. Powered by 4 alkaline batteries 1.5V LR6 (AA) (not included).

**A5A5609C00**

Electronic basin faucet (one water) . S-Size. Mains operated at 230V. Includes power source.

**A5A5709C00**



L20-E

Electronic basin faucet (pre-mixed water). S-Size. Powered by 4 alkaline batteries 1.5V LR6 (AA) (not included).

**A5A5309C00**

Electronic basin faucet (pre-mixed water). S-Size. Mains operated at 230V. Includes power source.

**A5A5509C00**



Loft-E

Electronic basin faucet (one water) with sensor integrated in the spout (DC). L-Size. Powered by 4 alkaline batteries 1.5V LR6 (AA).

**A5A4243C00**

Electronic basin faucet (one water) with sensor integrated in the spout (AC). L-Size. Mains operated at 230V. Includes power source.

**A5A4343C00**



Loft-E

Electronic basin faucet (one water) with sensor integrated in the spout (DC). XL-Size. Powered by 4 alkaline batteries 1.5V LR6 (AA).

**A5A3143C00**

Electronic basin faucet (one water) with sensor integrated in the spout (AC). XL-Size. Mains operated at 230V. Includes power source.

**A5A3943C00**



Loft-E

Electronic basin faucet (pre-mixed water) with sensor integrated in the spout (DC). L-Size. Powered by 4 alkaline batteries 1.5V LR6 (AA).

**A5A3243C00**

Electronic basin faucet (pre-mixed water) with sensor integrated in the spout (AC). L-Size. Mains operated at 230V. Includes power source.

**A5A3343C00**



Loft-E

Electronic basin faucet (pre-mixed water) with sensor integrated in the spout (DC). XL-Size. Powered by 4 alkaline batteries 1.5V LR6 (AA).

**A5A3743C00**

Electronic basin faucet (pre-mixed water) with sensor integrated in the spout (AC). XL-Size. Mains operated at 230V. Includes power source.

**A5A3843C00**



# Electronic Faucets



**Loft-E**  
Built-in electronic basin faucet (one water) with sensor integrated in the spout (DC) Powered by 4 alkaline batteries 1.5V LR6 (AA).

**A5A5643C00**

Built-in electronic basin faucet (one water) with sensor integrated in the spout (AC) Mains operated at 230V. Includes power source.

**A5A5743C00**



**Loft-E**  
Built-in electronic basin faucet (pre-mixed water) with sensor integrated in the spout (DC). Powered by 4 alkaline batteries 1.5V LR6 (AA).

**A5A3543C00**

Built-in electronic basin faucet (pre-mixed water) with sensor integrated in the spout (AC). Mains operated at 230V. Includes power source.

**A5A3643C00**



**Sentronic-E**  
Electronic built-in basin mixer. Mains operated at 230V. Includes power source. Internal subset required A525874603.

**A5A4602C00**

Internal subset.

**A525874603**



**Sentronic-E**  
Electronic basin faucet (one water). Mains operated at 230V. Includes power source. Internal subset required A525874603.

**A5A4702C00**

Internal subset.

**A525874603**

## Electronic Flush Valves



### Sentronic-R

Electronic flush valve for WC. Mains operated at 230V.

**A5A9102C00**



### Sentronic-V

Electronic urinal flush valve. Powered by 9V alkaline battery. Remote control to regulate the detection length and discharge time of the flush valve not included.

**A5A9A79C00**

Remote control for urinal. To regulate the detection distance and flushing time of the flush valve.

**A525081207**



### Sentronic-S

Electronic urinal flush valve.

**A5A8102..0**

Internal subset with stop valve. Powered by 4 alkaline batteries 1.5V LR6 (AA). Batteries not included.

**A525165203**

Internal subset with stop valve. Mains operated at 230V.

**A525165303**



# Instant Foot Self-closing Faucets

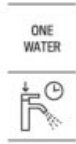

Instant Foot  
Self-closing foot pedal faucet. One water. Floorstanding.

**A505127800**

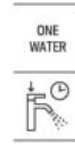

Instant Foot  
Self-closing foot pedal faucet. One water. Wall-mounted.

**A505127900**



Instant Foot  
Self-closing foot pedal mixer. Floorstanding.

**A505128600**



Instant Foot  
Self-closing foot pedal mixer. Wall-mounted.

**A505128700**



Instant Foot  
Deck-mounted spout.

**A505327000**



Instant Foot  
Wall spout.

**A505326900**



### Benefits

		ONE WATER	PRE-MIXED WATER	ΔECO
Touchless				
2L/min	3L/min	4L/min	5L/min	6L/min

### Finishes

● C0 Chrome

Unified Water Label	2 l/min
Unified Water Label	3 l/min
Unified Water Label	4 l/min
Unified Water Label	5 l/min
Unified Water Label	6 l/min

Replace (..) in the product reference with the code of the chosen finish.

# Instant self-closing faucets



Instant

Self-closing deck-mounted basin mixer with push-button, flow limiter to 6 litres/minute and automatic shut-off in 15 seconds.

**A5A3177C00**



Instant

Self-closing deck-mounted basin mixer with push button, flow limiter to 2 litres/minute and automatic shut-off in 15 seconds.

**A5A3377C00**

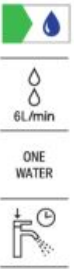

Instant

Self-closing deck-mounted basin faucet with push-button, flow limiter to 6 litres/minute and automatic shut-off in 15 seconds.

**A5A4277C00**

Self-closing deck-mounted basin faucet with push button, flow limiter to 6 litres/minute and automatic shut-off in 15 seconds. With anti-lock system.

**A5A4577C00**

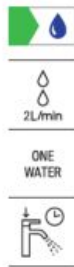

Instant

Self-closing deck-mounted basin faucet with push button, flow limiter to 2 litres/minute and automatic shut-off in 15 seconds.

**A5A4477C00**



Instant

Self-closing wall-mounted basin faucet with push button.

**A5A7877C00**



Instant

Exposed, angle shut-off cock for shower.

**A5A2777C00**



Instant

Self-closing built-in shut-off cock for shower with round wall-plate.

**A5A2677C00**



Instant

Exposed, angle shut-off cock for urinal.

**A5A9277C00**

External urinal pipe.

**A5A9317C00**



Instant

Built-in shut-off cock for urinal with round wall plate.

**A5A9077C00**

# Instant Care Self-closing Faucets



Instant Care

Self-closing deck-mounted basin mixer with temperature selector and gerontological handle.

**A5A3277C00**

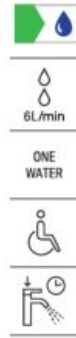

Instant Care

Self-closing deck-mounted basin faucet with gerontological handle.

**A5A4377C00**

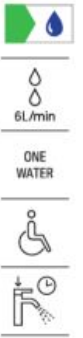

Instant Care

Self-closing wall-mounted basin faucet with gerontological handle.

**A5A7977C00**



Fluent

Self-closing deck-mounted basin mixer with push-button and aerator.

**A5A3A24C00**

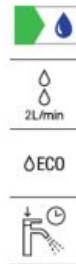

Fluent

ECO Self-closing deck-mounted basin mixer with push-button and aerator.

**A5A3B24C00**



Fluent

Self-closing deck-mounted basin faucet with aerator.

**A5A4A24C00**



Fluent

ECO Self-closing deck-mounted basin faucet with aerator.

**A5A4B24C00**



Fluent

Self-closing wall-mounted basin faucet with push button with aerator.

**A5A7A24C00**



Fluent

Exposed angle shut-off cock for urinal.

**A5A9B24C00**

External pipe for urinal.

**A5A9317C00**

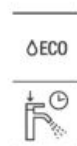

Fluent

ECO Exposed angle shut-off cock for urinal.

**A5A9D24C00**

External pipe for urinal.

**A5A9317C00**



Fluent

Built-in shut-off cock for urinal with round wall plate.

**A5A9A24C00**



Fluent

ECO Built-in shut-off cock for urinal with round wall plate.

**A5A9C24C00**

# Instant Self-closing Faucets



Avant  
Self-closing deck-mounted basin mixer with push-button with integrated selector for temperature regulation.

**A5A3279C00**

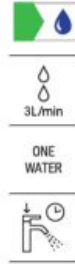

Avant  
Self-closing basin faucet with push-button.

**A5A4279C00**



Avant  
Self-closing deck-mounted basin mixer with push-button and lateral handle for temperature regulation.

**A5A3179C00**



Avant  
Self-closing wall-mounted basin faucet with push button and 150 mm long spout.

**A5A7879C00**

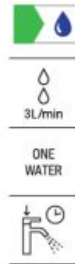

Avant  
Self-closing wall-mounted basin faucet with push button and 190 mm long spout.

**A5A7979C00**



Avant  
Self-closing built-in shower faucet with round wall plate. Push-button with temperature regulation integrated.

**A5A2217C00**



Avant  
Built-in thermostatic shower mixer.

**A5A0679C00**



Avant  
Thermostatic Micro-T Premixed water.

**A5A0179C00**



Avant  
Thermostatic Micro-T.

**A5A0279C00**



Avant  
Connection kit Micro-T.

**A505326203**



Avant  
Exposed, angle shut-off cock for urinal.  
**A5A9279C00**  
External urinal pipe.

**A5A9317C00**



Avant  
Built-in shut-off cock for urinal with round wall plate.

**A5A9079C00**



# Quick Guide

Insignia 
 L90 
 L90C 
 Pals 
 Loft 
 Carmen 
 Naia 
 Nu 

Basin - Deck-mounted - XS Size

Basin - Deck-mounted - S Size

Basin - Deck-mounted - M Size

Basin - Deck-mounted - L Size

Basin - Deck-mounted - XL Size

Basin - Built-in

Bidet - Deck-mounted

Bath-shower - Wall-mounted

Bath-shower - Built-in

Bath-shower - Deck-mounted

Bath-shower - Floorstanding

Bath spout

Shower - Wall-mounted

Shower - Built-in

Thermostatic built-in - Bath-shower

Thermostatic built-in - Shower

Thermostatic built-in - 3 way mixer

Shower column

Valves / Other faucets



Ona      Targa      Atlas      Monodin      Cala      L20      Alfa      Victoria Plus      Victoria      Brava



									•	•
•	•		•	•	•	•	•	•	•	•
•	•	•	•		•	•	•	•		•
	•	•					•			
•	•		•		•	•	•			
•	•	•	•	•	•	•	•			•
•	•	•	•	•	•	•	•	•	•	•
•	•	•	•	•	•	•	•	•	•	•
	•		•							
•	•									
•	•	•	•	•	•	•	•	•	•	•
•	•	•		•	•	•	•	•	•	
•			•							
•			•							
							•	•	•	
										•

























# Finishes Quick Guide











































	Insignia	L90	L90C	Pals	Loft	Carmen	Naia	Nu	Ona	Targa
CO Chrome										
CN Everlux Titanium Black										
RG Everlux Rose Gold										
NM Everlux Brushed Titanium Black										
VA Brushed Brass										
SM Stainless Steel Finish										
B0 Matt White										
NB Matt Black										
P0 Cobalt Blue										
P1 Honey Yellow										
P2 Mint Green										
P3 Glossy White										
CM Silver Grey										

Atlas    Monodin    Cala    L20    Alfa    Victoria Plus    Victoria    Brava    Filtración    Syra    Glera    Mencia



# Finishes Quick Guide

	T-2000	T-1000 Round	T-500	Shower packs	Thermostatic Shower columns	Shower columns	Bath spouts
CO Chrome							
CN Everlux Titanium Black							
RG Everlux Rose Gold							
NM Everlux Brushed Titanium Black							
VA Brushed Brass							
BO Matt White							
NB Matt Black							
CB Chrome / White							

Hand-showers	Shower kits	Shower sets	Shower-heads	Bars	Flexible shower hoses	Water inlets and brackets	Bidet kits
							
							
							
							
							
							
							
							



C0 Chrome



CN Titanium Black



RG Rose Gold



NM Brushed Titanium Black



VA Brushed Brass



SM Stainless Steel Finish



NB Matt Black

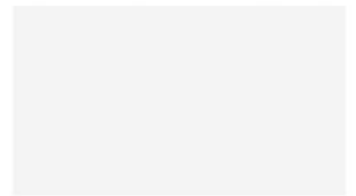

BO Matt White



P0 Cobalt Blue



P1 Honey Yellow



P2 Mint Green



P3 Glossy White

**Barcelona**  
**Since 1917**  
**81 Production facilities**  
**5 Continents**  
**21,000 People**  
**170 Markets**



Roca is a family-owned company dedicated to the design and production of solutions for the bathroom space. From our beginnings, we have grown into one of the largest producers of bathroom products in the world.



Our designs are intuitive and intentional, driven by a philosophy of continuous improvement. Our team of experts works with leading international designers to create products that push the boundaries of innovation, refining your bathroom while bringing comfort and simplicity to your daily routine.

Despite our presence in over 170 markets, we have remained close to our Barcelona roots, contributing to and drawing inspiration from its vibrant design culture. Our products are designed for efficiency and durability, and sustainability is ingrained in everything we do - from sourcing materials to production, logistics, packaging and shipping.

Beyond our products, we address critical challenges through We Are Water foundation, promoting sustainable water management and improving access to clean water in disadvantaged communities. We are also committed to fostering talent and creativity. Our design competitions provide opportunities for emerging designers, while our Roca Galleries and digital platform [rocagallery.com](http://rocagallery.com) host events, discussions, and feature articles on key global issues. As a leading multinational, we participate in key international events including Salone del Mobile, ISH, Expo Revestir, KBC and BDNY, sharing our values of innovation, sustainability, and teamwork.

We celebrate the small, everyday moments of domestic happiness. At the heart of our business is the desire to develop attractive and functional solutions that make people live the best bathroom experience.



**We make  
people live the  
best bathroom  
experience**

# Our contribution to a more sustainable future for all

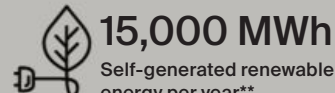
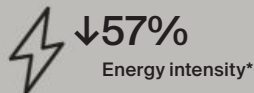



Our commitment to sustainable growth and development prioritises the wellbeing of people and the planet. This commitment is reflected in our efforts to foster strong societal relationships and support communities, as well as initiatives in decarbonisation, eco-design and circularity.

## Products

### Dual-flush mechanism

Dual flush cisterns offer adaptable water use, ensuring efficiency for different flushing requirements while reducing overall water consumption.

### Smart shower

Smart shower solutions allow programmable shower options and monitor water usage to encourage responsible and sustainable use.

### W+W

Integrating the washbasin and toilet into a single piece, this internationally acclaimed design reuses water from the washbasin to flush the toilet.

### Certificates

Many of our products are made from FSC®-certified wood, demonstrating that the materials come from responsibly managed forests.



### Unified Water Label

Many of our products are registered with the Unified Water Label scheme. This scheme identifies water-saving products that, when installed and used correctly, will use less water, saving energy and money.

The Water Label is used across Europe for most bathroom products.

Throughout our brochure, we have highlighted the faucets with the best water-saving performance, marking those that are 'best in class' in terms of water efficiency. The flow rate classification is measured at 3 bar pressure. For more information and complete details on water flow rates and classification, please visit [www.uwla.eu](http://www.uwla.eu)

\* Data from 2018-2023

\*\* Data from 2023

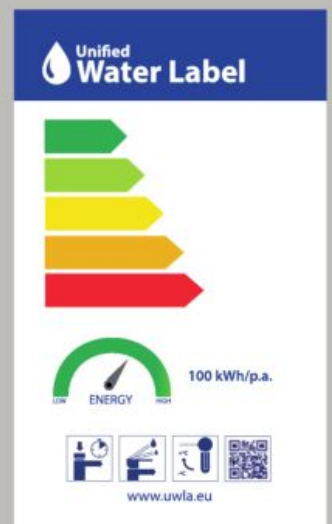

We create high-quality, durable products by considering their entire lifecycle, from carefully selected materials to optimised transport methods. Our aim is to combine the needs of society with environmental responsibility to deliver solutions that benefit everyone.

## Technologies

---

### Cold Start

Cold Start technology prevents unnecessary boiler activation by defaulting to a cold water start position. This innovation saves energy and reduces emissions released into the atmosphere.

### Aerators

Faucet spouts with aerators that mix air with water help to reduce the flow rate while maintaining the same functionality and comfort.

### Thermostatic faucets and fittings

Quick Reaction® technology delivers desired temperatures rapidly and an eco-stop button contribute to water conservation in showers.

## Materials

---

### Stonex®

An improved formula for Stonex® baths uses recycled PET bottles, reducing the carbon footprint by up to 25%.



## Initiatives

---

### Pioneering sustainable ceramics

Our recent partnership with Keramischer Ofenbau marks a significant step towards sustainability as we launched the world's first electric tunnel kiln for the production of sanitaryware.

This pioneering initiative positions us as a global leader in the operation of a net-zero sanitaryware manufacturing facility, setting a new standard for the industry.

Through collaboration and innovative technology, we aim to lead the way to a sustainable future for the ceramics industry.

## We Are Water

---

For over a decade, the We Are Water Foundation has promoted global hygiene and sustainable water management, improving access to clean water and sanitation in disadvantaged regions while raising awareness and providing training.



## Commitment

---

### Sustainable and Ethical Commitment

Roca Group is committed to implementing responsible business practices that prioritise environmental protection, social responsibility and ethical behaviour.



### EcoVadis Platinum Medal

recognises Roca Group's outstanding sustainability performance.



As a proud member of the **United Nations Global Compact**, sustainability forms an integral part of our commitment and we work in line with the targets of the **Sustainable Development Goals**.





[roca.com](http://roca.com)

    
[@roca\\_global](https://www.instagram.com/roca_global)

   
[@roca](https://www.youtube.com/roca)

  
[@rocaglobal](https://www.facebook.com/rocaglobal)

**Roca**  
